

Operating Manual

SUNNY TRIPOWER

5000TL/6000TL/7000TL/8000TL/9000TL/
10000TL/12000TL

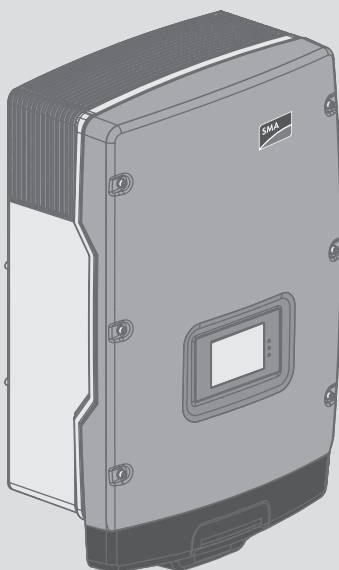

Legal Provisions

The information contained in these documents is property of SMA Solar Technology AG. Any publication, whether in whole or in part, requires prior written approval by SMA Solar Technology AG. Internal reproduction used solely for the purpose of product evaluation or other proper use is allowed and does not require prior approval.

SMA Warranty

You can download the current warranty conditions from the Internet at www.SMA-Solar.com.

Trademarks

All trademarks are recognized, even if not explicitly identified as such. Missing designations do not mean that a product or brand is not a registered trademark.

Modbus® is a registered trademark of Schneider Electric and is licensed by the Modbus Organization, Inc.

QR Code is a registered trademark of DENSO WAVE INCORPORATED.

Phillips® and Pozidriv® are registered trademarks of Phillips Screw Company.

Torx® is a registered trademark of Acument Global Technologies, Inc.

SMA Solar Technology AG

Sonnenallee 1

34266 Niestetal

Germany

Tel. +49 561 9522-0

Fax +49 561 9522-100

www.SMA.de

Email: info@SMA.de

Status: 8/20/2018

Copyright © 2017 SMA Solar Technology AG. All rights reserved.

Table of Contents

1	Information on this Document	6
1.1	Validity	6
1.2	Target Group	6
1.3	Additional Information.....	6
1.4	Symbols.....	7
1.5	Nomenclature	8
2	Safety	9
2.1	Intended Use.....	9
2.2	Safety Information	9
3	Scope of Delivery	12
4	Product Description	14
4.1	Sunny Tripower.....	14
4.2	Interfaces and Functions.....	17
5	Mounting.....	20
5.1	Requirements for Mounting.....	20
5.2	Mounting the Inverter	23
6	Electrical Connection	26
6.1	Safety during Electrical Connection	26
6.2	Overview of the Connection Area.....	27
6.2.1	View from Below.....	27
6.2.2	Interior View	28
6.3	AC Connection	29
6.3.1	Requirements for the AC Connection	29
6.3.2	Connecting the Inverter to the Utility Grid	30
6.3.3	Connecting Additional Grounding	31
6.4	Connecting the Multifunction Relay.....	32
6.4.1	Procedure for connecting the multifunction relay	32
6.4.2	Operating Modes of the Multifunction Relay	32
6.4.3	Connection Options	32
6.4.4	Connection to the Multifunction Relay	37

6.5	DC Connection	38
6.5.1	Requirements for the DC Connection	38
6.5.2	Connecting the PV Array.....	39
7	Commissioning	42
7.1	Commissioning Procedure.....	42
7.2	Configuring the Country Data Set.....	42
7.3	Setting the NetID	43
7.4	Commissioning the Inverter.....	45
8	Configuration.....	47
8.1	Configuration Procedure	47
8.2	Changing the Display Language.....	47
8.3	Connecting the Inverter to the Network.....	48
8.4	Integrating the Inverter into the Network	49
8.5	Changing Operating Parameters	49
8.6	Configuring the Modbus Function.....	50
8.7	Setting the Tripping Threshold of the Residual-Current Device	51
8.8	Changing the Operating Mode of the Multifunction Relay.....	51
8.9	Setting SMA OptiTrac Global Peak.....	52
9	Operation	53
9.1	LED Signals	53
9.2	Display Overview	53
9.3	Activating and Operating the Display	55
9.4	Calling Up Display Messages of the Start-Up Phase.....	56
10	Disconnecting the Inverter from Voltage Sources	57
11	Technical Data	59
11.1	DC/AC.....	59
11.1.1	Sunny Tripower 5000TL / 6000TL / 7000TL.....	59
11.1.2	Sunny Tripower 8000TL / 9000TL / 10000TL	61
11.1.3	Sunny Tripower 12000TL	63
11.2	General Data.....	64
11.3	Protective Devices.....	66

11.4 Climatic Conditions.....	66
11.5 Equipment	67
11.6 Torques.....	67
11.7 Multifunction Relay.....	67
11.8 Electronic Solar Switch.....	68
11.9 Data Storage Capacity.....	68
12 Accessories	69
13 Contact	70
14 EU Declaration of Conformity	73

1 Information on this Document

1.1 Validity

This document is valid for the following device types from firmware version 2.56.03.R:

- STP 5000TL-20 (Sunny Tripower 5000TL)
- STP 6000TL-20 (Sunny Tripower 6000TL)
- STP 7000TL-20 (Sunny Tripower 7000TL)
- STP 8000TL-20 (Sunny Tripower 8000TL)
- STP 9000TL-20 (Sunny Tripower 9000TL)
- STP 10000TL-20 (Sunny Tripower 10000TL)
- STP 12000TL-20 (Sunny Tripower 12000TL)

1.2 Target Group

This document is intended for qualified persons and end users. Only qualified persons are allowed to perform the activities marked in this document with a warning symbol and the caption "Qualified person". Tasks that do not require any particular qualification are not marked and can also be performed by end users. Qualified persons must have the following skills:

- Knowledge of how an inverter works and is operated
- Training in how to deal with the dangers and risks associated with installing and using electrical devices and installations
- Training in the installation and commissioning of electrical devices and installations
- Knowledge of the applicable standards and directives
- Knowledge of and compliance with this document and all safety information

1.3 Additional Information





Links to additional information can be found at www.SMA-Solar.com:

Document title and content	Document type
Troubleshooting, Cleaning, Replacement of Varistors and De-commissioning	Service Manual
"Application for SMA Grid Guard Code"	Form
"Overview of the Rotary Switch Settings" Overview of the rotary switch settings for configuring the country data set and display language	Technical Information
"Efficiency and Derating" Efficiency and Derating Behavior of the Sunny Boy, Sunny Tripower and Sunny Mini Central Inverters	Technical Information

Document title and content	Document type
"Insulation Resistance (Riso) of Non-Galvanically Isolated PV Systems" Information on Insulation Resistance of Non-Galvanically Isolated PV Systems	Technical Information
"Criteria for Selecting a Residual-Current Device" Criteria for Selecting a Residual-Current Device	Technical Information
"Circuit Breaker" Dimensioning and Selection of a Suitable AC Circuit Breaker for Inverters under PV-Specific Influences	Technical Information
"SMA Bluetooth® Wireless Technology in Practice" SMA BLUETOOTH range and safety	Technical Information
"SMA Bluetooth® Wireless Technology" Basics for planning a PV system with SMA BLUETOOTH	Technical Description
"SMA Modbus® Interface" Information on the commissioning and configuration of the SMA Modbus interface	Technical Information
"SMA Modbus® Interface" List with the product specific SMA Modbus registers	Technical Information
"SunSpec® Modbus® Interface" Information on the commissioning and configuration of the SunSpec Modbus interface	Technical Information
"SunSpec® Modbus® Interface" List with the product specific SunSpec Modbus registers	Technical Information
"Temperature Derating"	Technical Information
"Webconnect Systems in Sunny Portal" Registration in Sunny Portal and setting or changing operating parameters of the inverter	User Manual
"Parameters and Measured Values" Overview of All Inverter Operating Parameters and Their Configuration Options	Technical Information

1.4 Symbols

Symbol	Explanation
 DANGER	Indicates a hazardous situation which, if not avoided, will result in death or serious injury

Symbol	Explanation
 WARNING	Indicates a hazardous situation which, if not avoided, can result in death or serious injury
 CAUTION	Indicates a hazardous situation which, if not avoided, can result in minor or moderate injury
NOTICE	Indicates a situation which, if not avoided, can result in property damage
 QUALIFIED PERSON	Sections describing activities to be performed by qualified persons only
	Information that is important for a specific topic or goal, but is not safety-relevant
<input type="checkbox"/>	Indicates a requirement for meeting a specific goal
<input checked="" type="checkbox"/>	Desired result
×	A problem that might occur

1.5 Nomenclature

Complete designation	Designation in this document
Sunny Tripower	Inverter, product
Electronic Solar Switch	ESS

2 Safety

2.1 Intended Use

The Sunny Tripower is a transformerless PV inverter, with 2 MPP trackers, that converts the direct current of the PV array to grid-compliant, three-phase current and feeds it into the utility grid.

The product is suitable for indoor and outdoor use.

The product must only be operated with PV arrays of protection class II in accordance with IEC 61730, application class A. The PV modules must be compatible with this product.

The product is not equipped with a transformer and therefore has no galvanic isolation. The product must not be operated with PV modules whose outputs are grounded. This can cause the product to be destroyed. The product may be operated with PV modules whose frame is grounded.

PV modules with a high capacity to ground must only be used if their coupling capacity does not exceed 1.25 μF (for information on how to calculate the coupling capacity, see the Technical Information "Leading Leakage Currents" at www.SMA-Solar.com).

All components must remain within their permitted operating ranges at all times.

The product must only be used in countries for which it is approved or released by SMA Solar Technology AG and the grid operator.

The product is also approved for the Australian market and may be used in Australia. If DRM support is specified, the inverter may only be used in conjunction with a Demand Response Enabling Device (DRED). This ensures that the inverter implements the commands from the grid operator for active power limitation at all times. The inverter and the Demand Response Enabling Device (DRED) must be connected in the same network and the inverter Modbus interface must be activated and the TCP server set.

Use this product only in accordance with the information provided in the enclosed documentation and with the locally applicable standards and directives. Any other application may cause personal injury or property damage.

Alterations to the product, e.g. changes or modifications, are only permitted with the express written permission of SMA Solar Technology AG. Unauthorized alterations will void guarantee and warranty claims and in most cases terminate the operating license. SMA Solar Technology AG shall not be held liable for any damage caused by such changes.

Any use of the product other than that described in the Intended Use section does not qualify as the intended use.

The enclosed documentation is an integral part of this product. Keep the documentation in a convenient place for future reference and observe all instructions contained therein.

The type label must remain permanently attached to the product.

2.2 Safety Information

This section contains safety information that must be observed at all times when working on or with the product.

To prevent personal injury and property damage and to ensure long-term operation of the product, read this section carefully and observe all safety information at all times.

⚠ DANGER**Danger to life due to high voltages of the PV array**

When exposed to sunlight, the PV array generates dangerous DC voltage, which is present in the DC conductors and the live components of the inverter. Touching the DC conductors or the live components can lead to lethal electric shocks. If you disconnect the DC connectors from the inverter under load, an electric arc may occur leading to electric shock and burns.

- Do not touch non-insulated cable ends.
- Do not touch the DC conductors.
- Do not touch any live components of the inverter.
- Have the inverter mounted, installed and commissioned only by qualified persons with the appropriate skills.
- If an error occurs, have it rectified by qualified persons only.
- Prior to performing any work on the inverter, disconnect it from all voltage sources as described in this document.

⚠ DANGER**Danger to life due to electric shock**

Touching an ungrounded PV module or array frame can cause a lethal electric shock.

- Connect and ground the PV modules, array frame and electrically conductive surfaces so that there is continuous conduction. Observe the applicable local regulations.

⚠ CAUTION**Risk of burns due to hot enclosure parts**

Some parts of the enclosure can get hot during operation.

- During operation, do not touch any parts other than the enclosure lid of the inverter.

NOTICE**Damage to the seal of the enclosure lid in sub-zero conditions**

If you open the enclosure lid in sub-zero conditions, the sealing of the enclosure lid can be damaged. This can lead to moisture entering the inverter.

- Do not open the inverter at ambient temperatures lower than -5°C .
- If a layer of ice has formed on the seal of the enclosure lid in sub-zero conditions, remove it prior to opening the inverter (e.g. by melting the ice with warm air). Observe the applicable safety regulations.

NOTICE**Damage to the display or the type label due to the use of cleaning agents**

- If the inverter is dirty, clean the enclosure, the enclosure lid, the type label, the display and the LEDs with a damp cloth and clear water only.

3 Scope of Delivery

Check the scope of delivery for completeness and any externally visible damage. Contact your distributor if the scope of delivery is incomplete or damaged.

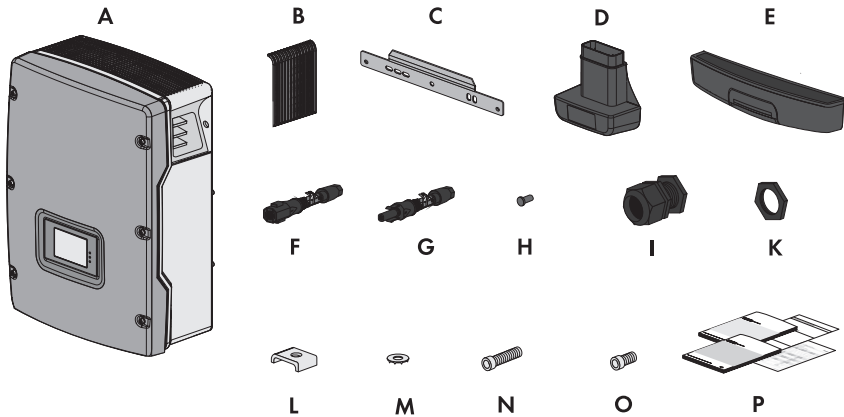

Figure 1: Components included in the scope of delivery

Position	Quantity	Designation
A	1	Inverter
B	2	Ventilation grid
C	1	Wall mounting bracket
D	1	Electronic Solar Switch
E	1	Protective cover
F	4	Negative DC connector
G	4	Positive DC connector
H	8	Sealing plug
I	1	Cable gland M32x1.5
K	1	Counter nut
L	1	Clamping bracket
M	2	Conical spring washer*
N	2	Cylindrical screw M6 x 16*

Position	Quantity	Designation
O	2	Cylindrical screw M6 x 8
P	1	Operating manual, supplementary sheet with default settings, supplementary sheet with information on SMA Speedwire/Webconnect, installation manual of the DC connectors

* One spare part for the enclosure lid included

4 Product Description

4.1 Sunny Tripower

The Sunny Tripower is a transformerless PV inverter, with 2 MPP trackers, that converts the direct current of the PV array to grid-compliant, three-phase current and feeds it into the utility grid.

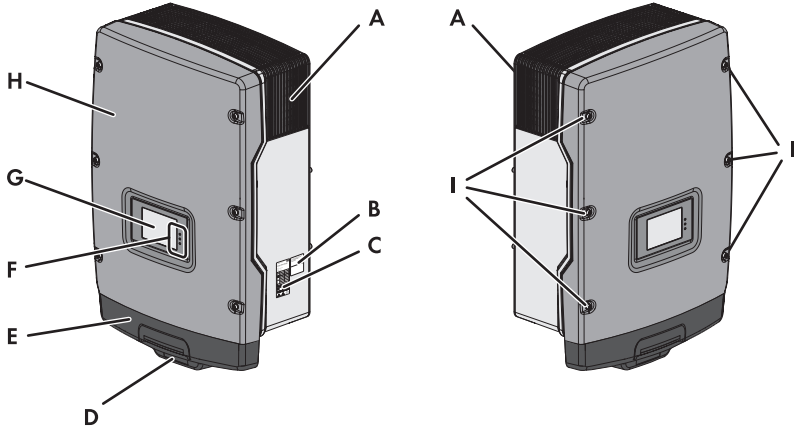





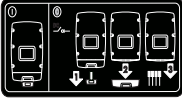







Figure 2: Design of the Sunny Tripower







Position	Designation
A	Ventilation grid
B	Additional label with details for registration in Sunny Portal: <ul style="list-style-type: none"> • Internet address of the PV System Setup Assistant • Identification key (PIC) • Registration ID (RID)
C	Type label The type label uniquely identifies the inverter. You will require the information on the type label to use the product safely and when seeking customer support from the SMA Service Line. You will find the following information on the type label: <ul style="list-style-type: none"> • Device type (Model) • Serial number (Serial No.) • Date of manufacture • Device-specific characteristics

Position	Designation
D	<p>Electronic Solar Switch (ESS)</p> <p>The ESS and the DC connectors together form a DC load-break switch. When plugged in, the ESS forms a conductive path between the PV array and the inverter. Removing the ESS interrupts the DC electric circuit and removing all DC connectors disconnects the PV array completely from the inverter.</p> <p>If the inverter is equipped with BLUETOOTH, the BLUETOOTH antenna is integrated in the ESS.</p>
E	Protective cover
F	<p>LEDs</p> <p>The LEDs indicate the operating state of the inverter (see Section 9.1 "LED Signals", page 53).</p>
G	<p>Display</p> <p>The display shows the current operating data and events or errors (see Section 9.2 "Display Overview", page 53).</p>
H	Enclosure lid
I	Screws and conical spring washers of the enclosure lid

Symbols on the inverter, the ESS and the type label

Symbol	Explanation
	<p>Inverter</p> <p>Together with the green LED, this symbol indicates the operating state of the inverter.</p>
	<p>Observe the documentation</p> <p>Together with the red LED, this symbol indicates an error (for troubleshooting, see the service manual at www.SMA-Solar.com).</p>
	<p>BLUETOOTH</p> <p>Together with the blue LED, this symbol indicates active BLUETOOTH communication (only in inverters equipped as standard with BLUETOOTH).</p>
	<p>Danger</p> <p>This symbol indicates that the inverter must be additionally grounded if additional grounding or equipotential bonding is required at the installation site (see Section 6.3.3 "Connecting Additional Grounding", page 31).</p>

Symbol	Explanation
	<p>Operating principle of the ESS:</p> <ul style="list-style-type: none"> • ① If the ESS is plugged in, the DC electric circuit is closed. • ② To interrupt the DC electric circuit, you must perform the following steps in the given order: <ul style="list-style-type: none"> - 1 Remove the ESS. - 2 Remove the protective cover. - 3 Unlock and remove all DC connectors.
	<p>Operating the inverter without a protective cover is prohibited. Always operate the inverter with a protective cover in place.</p>
	<p>Danger to life due to high voltages in the inverter; observe a waiting time of five minutes</p> <p>High voltages that can cause lethal electric shocks are present in the live components of the inverter. Prior to performing any work on the inverter, disconnect it from all voltage sources as described in this document (see Section 10, page 57).</p>
	<p>Danger to life due to electric shock</p> <p>The product operates at high voltages. All work on the product must be carried out by qualified persons only.</p>
	<p>Risk of burns due to hot surfaces</p> <p>The product can get hot during operation. Avoid contact during operation. Allow the product to cool down sufficiently before carrying out any work.</p>
	<p>Observe the documentation</p> <p>Observe all documentation supplied with the product.</p>
	<p>Direct current</p>
	<p>The product does not have a transformer.</p>
	<p>Three-phase alternating current with neutral conductor</p>

Symbol	Explanation
	WEEE designation Do not dispose of the product together with the household waste but in accordance with the locally applicable disposal regulations for electronic waste.
	CE marking The product complies with the requirements of the applicable EU directives.
	Device class ID (printed only if the inverter is equipped with BLUETOOTH) The product is equipped with a wireless component and complies with device class 2.
IP65	Degree of protection IP65 The product is protected against dust intrusion and water jets from any angle.
	The product is suitable for outdoor installation.
	Certified safety The product is VDE-tested and complies with the requirements of the German Equipment and Product Safety Act.
	RCM (Regulatory Compliance Mark) The product complies with the requirements of the applicable Australian standards.

4.2 Interfaces and Functions

The inverter can be equipped or retrofitted with the following interfaces and functions:

BLUETOOTH

The inverter is equipped with BLUETOOTH as a standard feature depending on the date of manufacture. Via BLUETOOTH, the inverter can communicate with various BLUETOOTH devices (for information on supported SMA products, see www.SMA-Solar.com).

SMA Speedwire/Webconnect

The inverter is equipped with SMA Speedwire/Webconnect as standard. SMA Speedwire/Webconnect is a type of communication based on the Ethernet standard. This enables inverter-optimized 10/100 Mbit data transmission between Speedwire devices in PV systems and the software Sunny Explorer. The Webconnect function enables direct data transmission between the inverters of a small-scale system and the Internet portal Sunny Portal without any additional

communication device and for a maximum of 4 inverters per Sunny Portal system. In large-scale PV power plants, data transmission to the Internet portal Sunny Portal is carried out via the SMA Cluster Controller. You can access your Sunny Portal system from any computer with an Internet connection.

Webconnect enables - for PV systems operated in Italy - the connection or disconnection of the inverter to or from the utility grid and the specifying of the frequency limits to be used via IEC61850-GOOSE messages.

Modbus

The inverter is equipped with a Modbus interface. The Modbus interface is deactivated by default and must be configured as needed.

The Modbus interface of the supported SMA devices is designed for industrial use and has the following tasks:

- Remote query of measured values
- Remote setting of operating parameters
- Setpoint specifications for system control

RS485 interface or SMA Power Control Module

The inverter can communicate via cables with special SMA communication products via the RS485 interface (information on supported SMA products at www.SMA-Solar.com).

The SMA Power Control Module enables the inverter to implement grid management services and is equipped with an additional multifunction relay (for information on installation and configuration, see the installation manual of the SMA Power Control Module).

The RS485 interface and the SMA Power Control Module can be retrofitted and may not be operated in parallel.

If you want to operate the RS485 interface or the SMA Power Control Module in parallel with the multifunction relay in the inverter, you must ensure that a voltage of no more than 30 V DC or 25 V AC is connected to the multifunction relay.

Grid Management Services

The inverter is equipped with service functions for grid management.

Depending on the requirements of the grid operator, you can activate and configure the functions (e.g. active power limitation) via operating parameters.

Multifunction Relay

The inverter is equipped with a multifunction relay as standard. The multifunction relay is an interface that can be configured for the operating mode used by a particular system.

Error message required by standard

In some countries, signaling of errors is required by standards, e.g. IEC 62109-2. In order to meet the standard requirement, take one of the following measures:

- Operate the multifunction relay in the operating mode **Fault indication** or **FtInd** and connect a display unit to the multifunction relay that signals an error or the undisturbed operation of the inverter.
- Activate the error alarm in Sunny Portal (for information on receiving error alarms via Sunny Portal, see the Sunny Portal user manual at www.SunnyPortal.com). This requires the inverter to be registered in Sunny Portal.

SMA OptiTrac Global Peak

SMA OptiTrac Global Peak is an advancement of SMA OptiTrac and allows the operating point of the inverter to follow the optimal operating point of the PV array (MPP) precisely at all times. In addition, with the aid of SMA OptiTrac Global Peak, the inverter detects several maximum power points in the available operating range, such as may occur particularly with partially shaded strings. SMA OptiTrac Global Peak is enabled by default.

All-pole sensitive residual-current monitoring unit

The all-pole sensitive residual-current monitoring unit detects alternating and direct differential currents. In single-phase and three-phase inverters, the integrated differential current sensor detects the current difference between the neutral conductor and the line conductor(s). If the current difference increases suddenly, the inverter disconnects from the utility grid.

5 Mounting

5.1 Requirements for Mounting

Requirements for the mounting location:

⚠ WARNING

Danger to life due to fire or explosion

Despite careful construction, electrical devices can cause fires.

- Do not mount the product in areas containing highly flammable materials or gases.
- Do not mount the product in potentially explosive atmospheres.

- Do not mount the inverter on a pillar.
- The mounting location must be inaccessible to children.
- A solid support surface must be available for mounting, e.g. concrete or masonry. When mounted on drywall or similar materials, the inverter emits audible vibrations during operation which could be perceived as annoying.
- The mounting location must be suitable for the weight and dimensions of the inverter (see Section 11 "Technical Data", page 59).
- The mounting location must not be exposed to direct solar irradiation. Direct solar irradiation can result in the premature aging of the exterior plastic parts of the inverter and direct solar irradiation can cause the inverter to overheat. When becoming too hot, the inverter reduces its power output to avoid overheating.
- The mounting location should be freely and safely accessible at all times without the need for any auxiliary equipment (such as scaffolding or lifting platforms). Non-fulfillment of these criteria may restrict servicing.
- To ensure optimum operation, the ambient temperature should be between -25°C and 40°C.
- Climatic conditions must be met (see Section 11 "Technical Data", page 59).

Permitted and prohibited mounting positions:

- The inverter must only be mounted in one of the permitted positions. This will ensure that no moisture can penetrate the inverter.
- The inverter should be mounted in such way that display messages and LED signals can be read without difficulty.

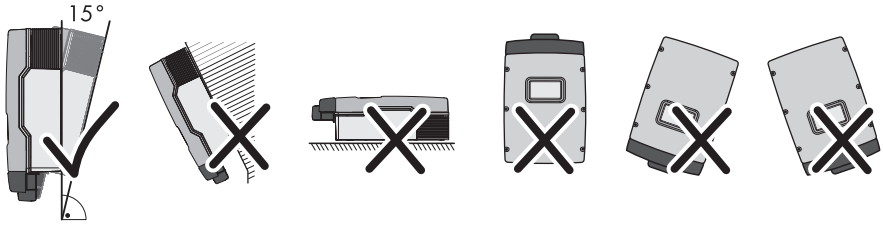

Figure 3: Permitted and prohibited mounting positions

Dimensions for mounting:

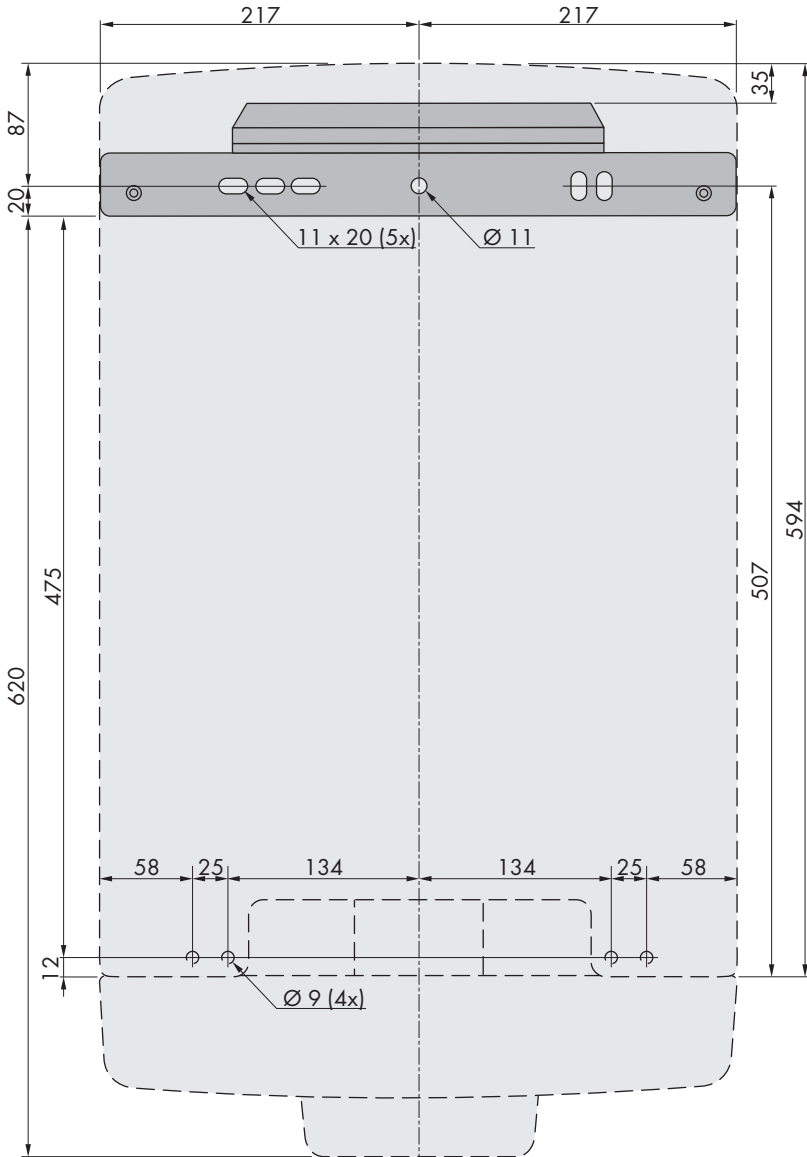

Figure 4: Position of the anchoring points (dimensions in mm (in))

Recommended clearances:

If you maintain the recommended clearances, adequate heat dissipation will be ensured. Thus, you will prevent power reduction due to excessive temperature.

- Maintain the recommended clearances to walls as well as to other inverters or objects.
- If multiple inverters are mounted in areas with high ambient temperatures, increase the clearances between the inverters and ensure sufficient fresh-air supply.

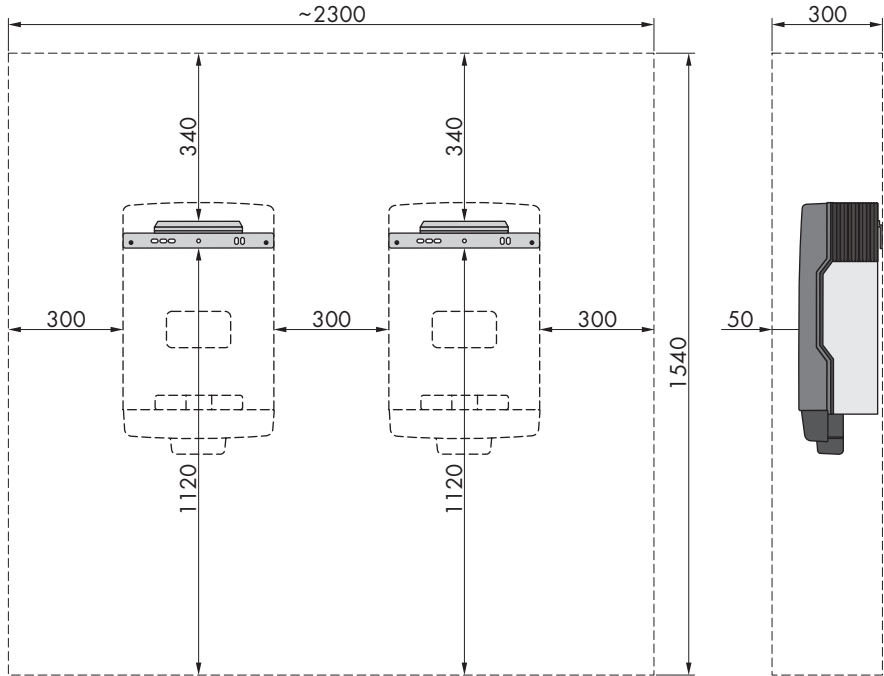

Figure 5: Recommended clearances (dimensions in mm (in))

5.2 Mounting the Inverter

⚠ QUALIFIED PERSON

Additionally required mounting material (not included in the scope of delivery):

- At least two screws that are suitable for the support surface and the weight of the inverter
- At least two washers that are suitable for the screws
- If necessary, two screw anchors suitable for the support surface and the screws
- To protect the inverter against theft: At least one security screw and, if necessary, a suitable screw anchor

⚠ CAUTION

Risk of injury when lifting the inverter, or if it is dropped

The inverter weighs 38 kg. There is risk of injury if the inverter is lifted incorrectly or dropped while being transported or when attaching it to or removing it from the wall mounting bracket.

- Carry and lift the inverter upright with the help of several people. Use both hands to grasp the recessed grips at the top and bottom, or use a steel rod (diameter: 30 mm at maximum). This will prevent the inverter from tipping forward.

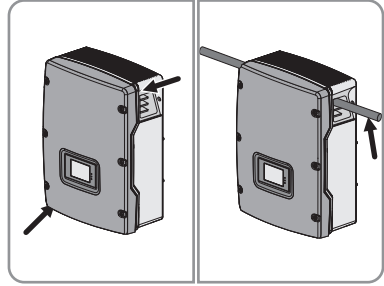

NOTICE

Damage to the ESS pin connector from dirt and foreign bodies

In single-phase and three-phase inverters, the integrated differential current sensor detects the current difference between the neutral conductor and the line conductor(s). This will impair the function of the ESS.

- Always set the inverter down on a level support surface or lay it on its back.

Procedure:

1. ⚠ CAUTION

Risk of injury due to damaged cables

There may be power cables or other supply lines (e.g. gas or water) routed in the wall.

- Ensure that no lines are laid in the wall which could be damaged when drilling holes.
2. Align the wall mounting bracket horizontally on the wall and use it to mark the position of the drill holes. Use at least one hole on the right-hand and left-hand side in the wall mounting bracket.
 3. Set the wall mounting bracket aside and drill the marked holes.
 4. Insert screw anchors into the drill holes if the support surface requires them.
 5. Secure the wall mounting bracket horizontally using screws and washers.
 6. If the inverter is to be secured against theft, mark one drill hole or two drill holes for the attachment of the security screw:
 - Hook the inverter into the wall mounting bracket.

- Mark the drill hole on the left-hand or right-hand side. If you want to secure the inverter with two safety screws, mark one drill hole on the left-hand side and one on the right-hand side.

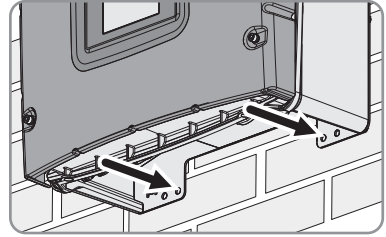

- Remove the inverter by lifting it vertically up and off the wall mounting bracket.
- Drill the hole or holes to attach the safety screw(s) and insert the screw anchor(s).

7. Hook the inverter into the wall mounting bracket.

8. Secure the inverter to the wall mounting bracket on both sides using the M6x8 screws provided and an Allen key (AF 5). Only tighten the screws hand-tight.

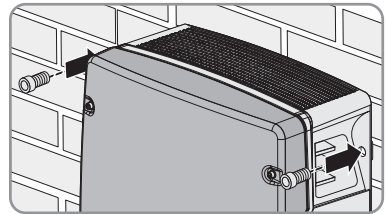

9. Close the recessed grips with the ventilation grids. Ensure that the assignment is correct. The correct assignment is marked on the inside of each ventilation grid: **links/left** for the left-hand side and **rechts/right** for the right-hand side.

10. Once the holes for attaching the safety screw have been pre-drilled, secure the inverter with at least one safety screw through the pre-drilled hole.

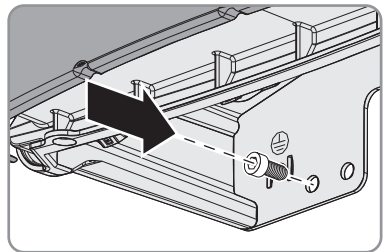

11. Ensure that the inverter is securely in place.

6 Electrical Connection

6.1 Safety during Electrical Connection

⚠ DANGER

Danger to life due to high voltages of the PV array

When exposed to sunlight, the PV array generates dangerous DC voltage, which is present in the DC conductors and the live components of the inverter. Touching the DC conductors or the live components can lead to lethal electric shocks. If you disconnect the DC connectors from the inverter under load, an electric arc may occur leading to electric shock and burns.

- Do not touch non-insulated cable ends.
- Do not touch the DC conductors.
- Do not touch any live components of the inverter.
- Have the inverter mounted, installed and commissioned only by qualified persons with the appropriate skills.
- If an error occurs, have it rectified by qualified persons only.
- Prior to performing any work on the inverter, disconnect it from all voltage sources as described in this document.

NOTICE

Damage to seals on the enclosure lids in subfreezing conditions

If you open the enclosure lid when temperatures are below freezing, the enclosure lid seal could be damaged. This can lead to moisture entering the inverter.

- Only open the enclosure lid if the ambient temperature is not below -5°C
- If a layer of ice has formed on the seal of the lid when temperatures are below freezing, remove it prior to opening the enclosure lid (e.g. by melting the ice with warm air). Observe the applicable safety regulations.

NOTICE

Damage to the inverter due to electrostatic discharge

Touching electronic components can cause damage to or destroy the inverter through electrostatic discharge.

- Ground yourself before touching any component.

6.2 Overview of the Connection Area

6.2.1 View from Below

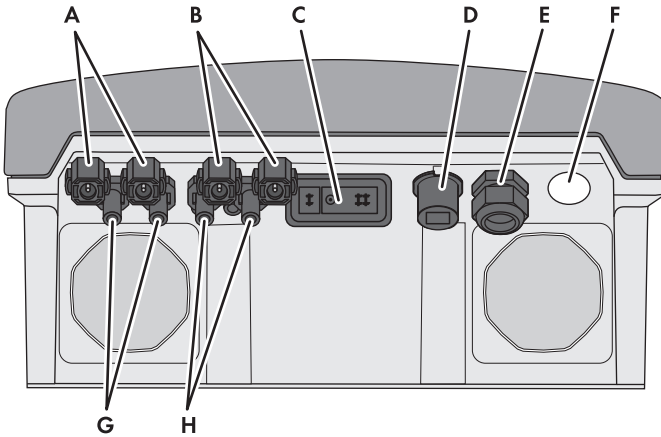

Figure 6: Connection areas and enclosure openings at the bottom of the inverter

Position	Designation
A	Positive DC connectors, input A
B	Positive DC connectors, input B
C	Pin connector for the ESS
D	Pin connector with filler plug for the network connection
E	Cable gland M25 with filler plug for the data cables
F	Enclosure opening for the AC cable
G	Negative DC connectors, input A
H	Negative DC connectors, input B

6.2.2 Interior View

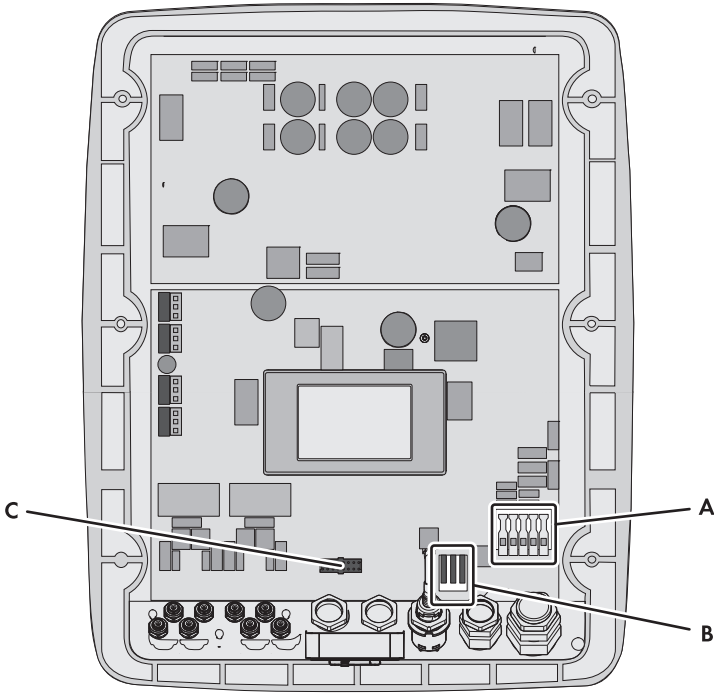

Figure 7: Connection areas in the interior of the inverter

Position	Designation
A	Connecting terminal plate for the AC cable
B	Multifunction relay with protective cover
C	Slot for 485 Data Module Type B or SMA Power Control Module

6.3 AC Connection

6.3.1 Requirements for the AC Connection

Cable requirements:

- External diameter: 12 mm to 21 mm
- Conductor cross-section: 1.5 to 6 mm²
- Insulation stripping length: 18 mm
- The cable must be dimensioned in accordance with the local and national directives for the dimensioning of cables. The requirements for the minimum wire size derive from these directives. Examples of factors influencing cable dimensioning are: nominal AC current, type of cable, routing method, cable bundling, ambient temperature and maximum desired line losses (for calculation of line losses, see the design software "Sunny Design" from software version 2.0 at www.SMA-Solar.com).

Load-break switch and cable protection:

NOTICE

Damage to the inverter due to the use of screw-type fuses as load-break switches

Screw-type fuses (e.g. DIAZED fuse or NEOZED fuse) are not load-break switches.

- Do not use screw-type fuses as load-break switches.
- Use a load-break switch or circuit breaker as a load disconnection unit (for information and design examples, see the Technical Information "Circuit Breaker" at www.SMA-Solar.com).

- In PV systems with multiple inverters, protect each inverter with a separate three-phase circuit breaker. Make sure to observe the maximum permissible fuse protection (see Section 11 "Technical Data", page 59). This will prevent residual voltage being present at the corresponding cable after disconnection.
- Loads installed between the inverter and the circuit breaker must be fused separately.

Residual-current monitoring unit:

- If an external residual-current device is required, install a residual-current device which trips at a residual current of 100 mA or higher (for details on selecting a residual-current device, see the Technical Information "Criteria for Selecting a Residual-Current Device" at www.SMA-Solar.com).
- If a residual-current device with a tripping threshold of 30 mA is required and used, you must set the tripping threshold of the residual-current device in the inverter to 30 mA (see Section 8.7, page 51).

Overvoltage category:

The inverter can be used in grids of overvoltage category III or lower in accordance with IEC 60664-1. That means that the inverter can be permanently connected to the grid-connection point of a building. In case of installations with long outdoor cabling routes, additional measures to reduce overvoltage category IV to overvoltage category III are required (see the Technical Information "Overvoltage Protection" at www.SMA-Solar.com).

6.3.2 Connecting the Inverter to the Utility Grid**⚠ QUALIFIED PERSON****Requirements:**

- The connection requirements of the grid operator must be met.
- The grid voltage must be in the permissible range. The exact operating range of the inverter is specified in the operating parameters.

Procedure:

1. Disconnect the circuit breaker from all three line conductors and secure against reconnection.
2. Unscrew all six screws of the enclosure lid using an Allen key (AF 5) and remove the enclosure lid. Ensure that the conical spring washers are retained.
3. Remove the adhesive tape from the enclosure opening for the AC cable.
4. Attach the M32x1.5 cable gland to the enclosure opening for the AC cable using a counter nut.
5. Route the AC cable into the inverter through the cable gland. If necessary, slightly loosen the swivel nut of the cable gland.
6. Dismantle the AC cable.
7. Shorten L1, L2, L3 and N by 5 mm each.
8. Strip 18 mm of the insulation from each of L1, L2, L3, N and the grounding conductor.
9. Push the safety levers of the AC connecting terminal plate right up to the stop.

10. ⚠ CAUTION**Risk of fire if two conductors are connected to one terminal**

If you connect two conductors to a terminal, a fire can occur due to a bad electrical connection.

- Never connect more than one conductor per terminal.

11. Connect PE, N, L1, L2 and L3 to the connecting terminal plate for the AC cable according to the labeling. The direction of the rotating magnetic field of L1, L2 and L3 is not relevant.

12. **⚠ CAUTION**

Danger of crushing fingers when locking levers snap shut

The locking levers close by snapping down fast and hard.

- Press the locking levers of the connecting terminal plate for the AC cable down with your thumb only.
- Do not grip the entire connecting terminal plate for the AC cable.
- Do not place your fingers under the locking levers.

13. Make sure that all conductors are securely in place.

14. Tighten the swivel nut of the cable gland.

6.3.3 Connecting Additional Grounding

⚠ QUALIFIED PERSON

If additional grounding or equipotential bonding is required locally, you can connect additional grounding to the inverter. This prevents touch current if the grounding conductor at the terminal for the AC cable fails. The required clamping bracket, the screw and the conical spring washer are part of the scope of delivery of the inverter.

Cable requirement:

- Grounding cable cross-section: 16 mm² at maximum

Procedure:

1. Strip the grounding cable insulation.
2. Lead the clamping bracket over the grounding cable. Arrange the grounding cable on the left-hand side.
3. Screw the clamping bracket tight using the M6x16 cylindrical screw and the conical spring washer M6 (torque: 6 Nm). The teeth of the conical spring washer must face the clamping bracket.

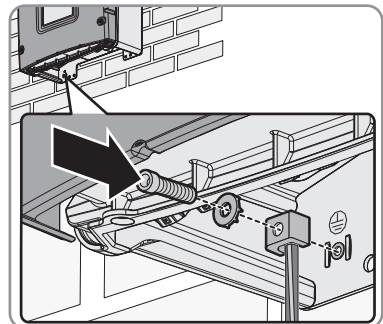
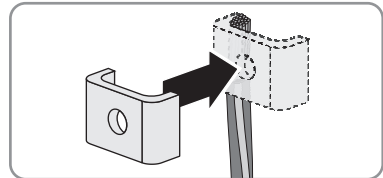

6.4 Connecting the Multifunction Relay

6.4.1 Procedure for connecting the multifunction relay

QUALIFIED PERSON

Procedure	See
1. Select for which operating mode you would like to use the multifunction relay.	Section 6.4.2, page 32
2. Connect to the multifunction relay according to the operating mode and the associated connection variant.	Section 6.4.3, page 32 and Section 6.4.4, page 37
3. After commissioning the inverter, change the operating mode of the multifunction relay, if necessary.	User manual under www.SMA-Solar.com

6.4.2 Operating Modes of the Multifunction Relay

Operating mode of multifunction relay (Mlt.Op-Mode)	Description
Fault indication (FltInd)	The multifunction relay controls a display device (e.g. a warning light) which, depending on the type of connection, signals either an error or the undisturbed operation of the inverter.
Self-consumption (SelfC-mp)	The multifunction relay switches loads on or off, depending on the power production of the PV system.
Control via communication (ComCtl)	The multifunction relay switches loads on or off according to commands transmitted by a communication product.
Battery bank (BatCha)	The multifunction relay controls the charging of the batteries depending on the power production of the PV system.
Fan control (FanCtl)	The multifunction relay controls an external fan, depending on the temperature of the inverter.
Switching status grid relay (GriSwCpy)	The local grid operator may require that a signal is transmitted as soon as the inverter connects to the utility grid. The multifunction relay can be used to trigger this signal.

6.4.3 Connection Options

The connection procedures vary, depending on the operating mode.

Operating mode	Connection option
Fault indication (FltInd)	Using the Multifunction Relay as a Fault Indicator Contact
Self-consumption (SelfC-mp)	Controlling loads via the multifunction relay or charging batteries depending on the power production of the PV system

Operating mode	Connection option
Control via communication (ComCtl)	Controlling loads via the multifunction relay or charging batteries depending on the power production of the PV system
Battery bank (BatCha)	Controlling loads via the multifunction relay or charging batteries depending on the power production of the PV system
Fan control (FanCtl)	Connecting the external fan (see fan documentation)
Switching status grid relay (GriSwCpy)	Reporting the switching status of the grid relay

Using the Multifunction Relay as a Fault Indicator Contact

You can use the multifunction relay as a fault indicator contact and have an error or smooth operation of the inverter displayed or signaled via a suitable display device. You can connect multiple inverters to one fault indicator or operation indicator, as needed.

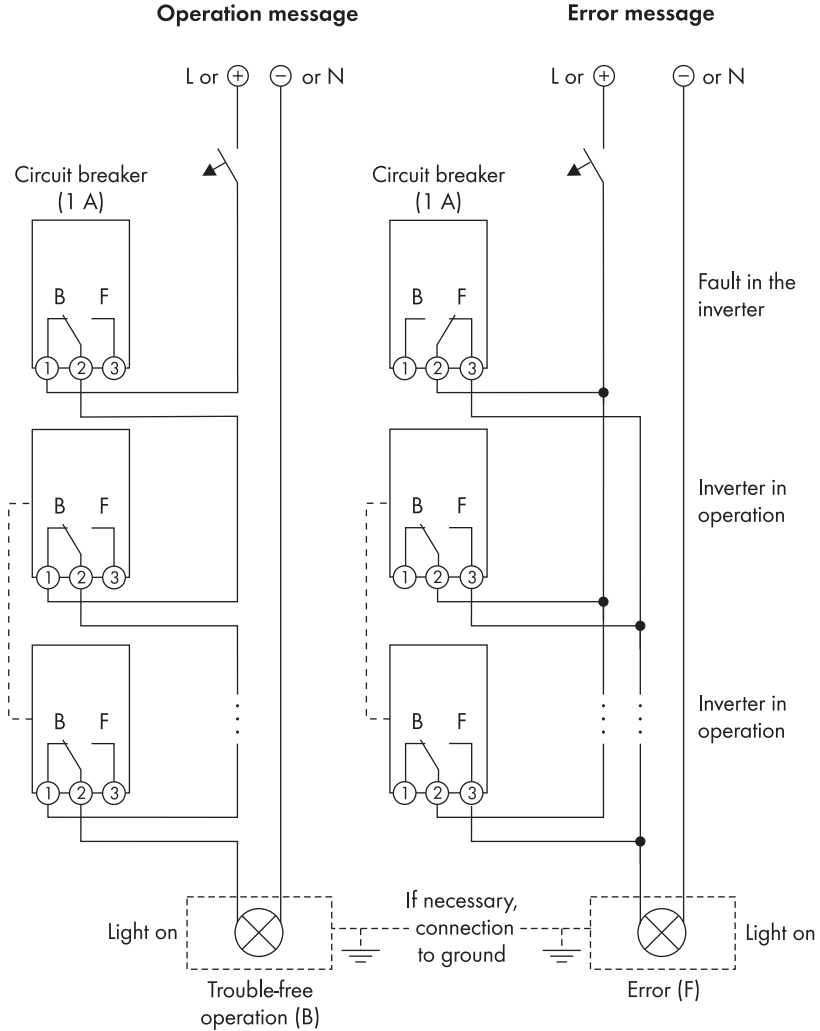

Figure 8: Circuit diagram with multiple inverters for connection to an operation indicator and circuit diagram for connection to a fault indicator (example)

Controlling loads via the multifunction relay or charging batteries depending on the power production of the PV system

The multifunction relay can control loads or charge batteries power-dependently. To enable this function, you must connect a contactor (K1) to the multifunction relay. The contactor (K1) switches the operating current for the load on or off. If you want batteries to be charged depending on the available power, the contactor activates or deactivates the charging of the batteries.

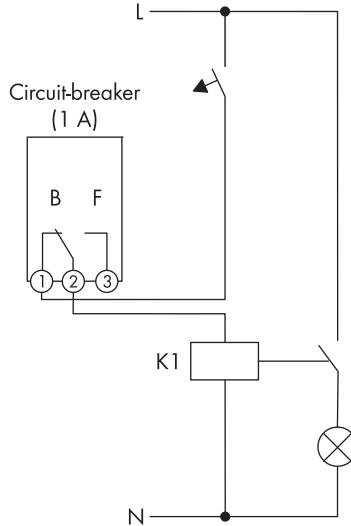

Figure 9: Wiring diagram for connection for controlling a load or for the power-dependent charging of the batteries

Reporting the switching status of the grid relay

The multifunction relay can trip a signal to the grid operator as soon as the inverter connects to the utility grid. To enable this function, the multifunction relays of all inverters must be connected in parallel.

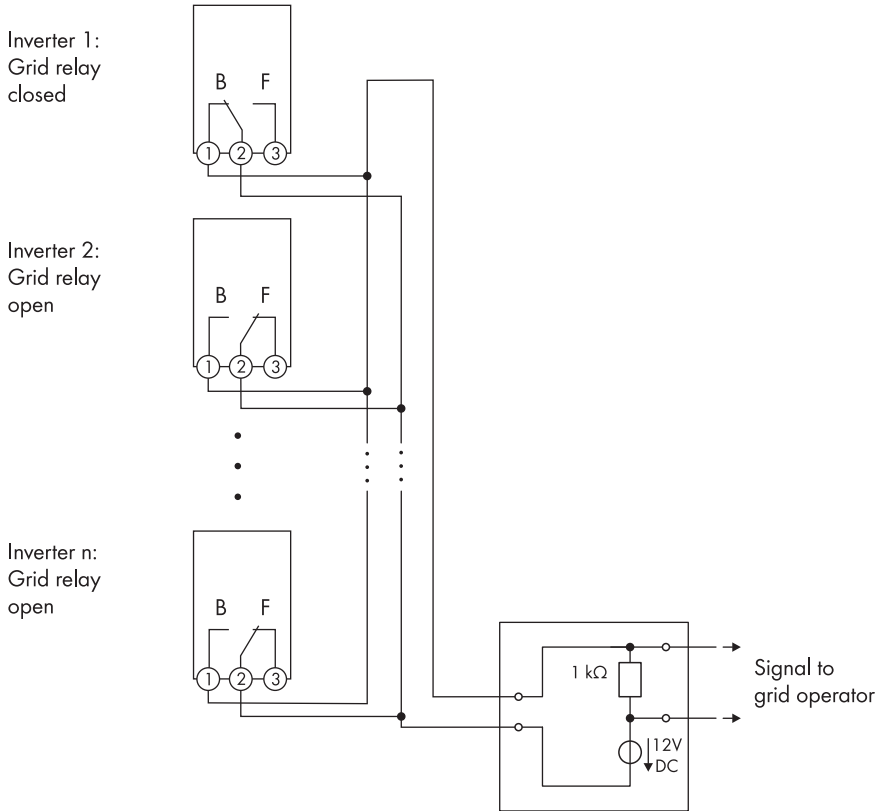

Figure 10: Wiring diagram for signaling the switching status of the grid relay (example)

6.4.4 Connection to the Multifunction Relay

⚠ QUALIFIED PERSON

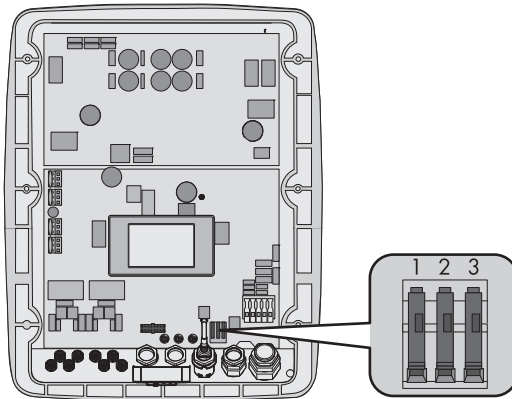

Figure 11: Connecting terminal plate for the connection to the multifunction relay

Requirement:

- The technical requirements of the multifunction relay must be met (see Section 11 "Technical Data", page 59).

Cable requirements:

- The cable must be double-insulated.
- External diameter: 5 mm to 12 mm
- Conductor cross-section: 0.08 mm² ... 2.5 mm²
- The cable type and cable-laying method must be appropriate for the application and location.

NOTICE

Destruction of the multifunction relay as a result of excessive contact load

- Observe the maximum switching voltage and maximum switching current (see Section 11 "Technical Data", page 59).
- When connecting the multifunction relay to the utility grid, fuse the multifunction relay with a separate circuit breaker.

i Operating the multifunction relay and 485 Data Module Type B or SMA Power Control Module in parallel

If you want to operate the multifunction relay and the 485 Data Module Type B or the SMA Power Control Module in parallel, a voltage of no more than 30 V DC or 25 V AC may be connected to the multifunction relay.

Procedure:

1. When connecting to the utility grid, fuse the multifunction relay with a separate circuit breaker.

2. **⚠ DANGER**

Danger to life due to high voltages

- Ensure that the inverter is disconnected from all voltage sources (see Section 10, page 57).

3. Prepare the cable:

- Dismantle the cable by no more than 15 mm.
- Strip off the conductor insulation by max. 8 mm.

4. Prepare the cable gland M25 for the connection to the multifunction relay as follows:

- Remove the swivel nut from the cable gland and remove the filler plug.
- Remove the one-hole cable support sleeve from the cable gland and insert the cable into the one-hole cable support sleeve.
- Press the one-hole cable support sleeve with the cable into the cable gland and lead the cable into the inverter.
- Screw the swivel nut onto the cable gland.

5. Remove the protective cover of the multifunction relay.

6. Depending on the operating mode, connect the cable to the connecting terminal plate for the connection to the multifunction relay in accordance with the circuit diagram (see Section 6.4.3, page 32).

7. **⚠ WARNING**

Danger to life due to live cables

If, during inverter operation, an insulated conductor (L1, L2 or L3) becomes detached from the AC terminal, there is a risk of the multifunction relay cables being live. Touching the cables can cause fatal electric shock.

- Reattach the protective cover to the multifunction relay. This isolates the AC connection area in the inverter from other terminals.

8. Tighten the swivel nut of the cable gland.

6.5 DC Connection

6.5.1 Requirements for the DC Connection

Requirements for the PV modules per input:

- All PV modules must be of the same type.
- All PV modules must be aligned and tilted identically.
- On the coldest day based on statistical records, the open-circuit voltage of the PV array must never exceed the maximum input voltage of the inverter.

- The same number of series-connected PV modules must be connected to each string.
- The maximum input current per string must be maintained and must not exceed the through-fault current of the DC connectors (see Section 1.1 "Technical Data", page 59).
- The thresholds for the input voltage and the input current of the inverter must be adhered to (see Section 1.1 "Technical Data", page 59).
- The positive connection cables of the PV modules must be fitted with the positive DC connectors (for information on assembling DC connectors, see the DC connector installation manual).
- The negative connection cables of the PV modules must be fitted with the negative DC connectors (for information on assembling DC connectors, see the DC connector installation manual).

i Use of Y adapters for parallel connection of strings

The Y adapters must not be used to interrupt the DC circuit.

- Do not use the Y adapters in the immediate vicinity of the inverter. The adapters must not be visible or freely accessible.
- In order to interrupt the DC circuit, always disconnect the inverter as described in this document (see Section 10, page 57).

6.5.2 Connecting the PV Array

⚠ QUALIFIED PERSON

NOTICE

Destruction of the inverter due to overvoltage

If the open-circuit voltage of the PV modules exceeds the maximum input voltage of the inverter, the inverter can be destroyed due to overvoltage.

- If the open-circuit voltage of the PV modules exceeds the maximum input voltage of the inverter, do not connect any strings to the inverter and check the design of the PV system.

NOTICE

Destruction of the measuring device due to overvoltage

- Only use measuring devices with a DC input voltage range of 1 000 V or higher.

Procedure:

1. Ensure that the circuit breaker is switched off from all three line conductors and that it cannot be reconnected.
2. If the ESS is plugged in, remove the ESS.
3. If the protective cover is mounted, loosen the two screws of the protective cover using an Allen key (AF 5) and remove the protective cover.

4. Ensure that there is no ground fault in the PV array (see service manual at www.SMA-Solar.com).

5. Check whether the DC connectors have the correct polarity.

If the DC connector is equipped with a DC cable of the wrong polarity, the DC connector must be assembled again. The DC cable must always have the same polarity as the DC connector.

6. Ensure that the open-circuit voltage of the PV array does not exceed the maximum input voltage.

7. Connect the assembled DC connectors to the inverter.

- The DC connectors snap into place.

8. **NOTICE**

Damage to the inverter due to moisture ingress

The inverter is only properly sealed when all unused DC inputs are closed with DC connectors and sealing plugs.

- Do not insert the sealing plugs directly into the DC inputs on the inverter.
- For unused DC connectors, push down the clamping bracket and push the swivel nut up to the thread.

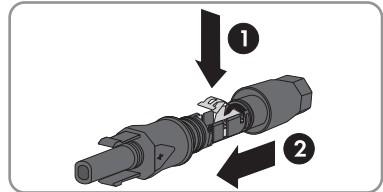

- Insert the sealing plug into the DC connector.

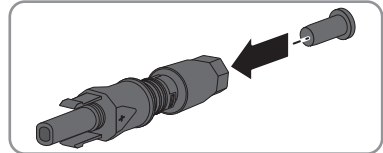

- Tighten the DC connector (torque: 2 Nm).

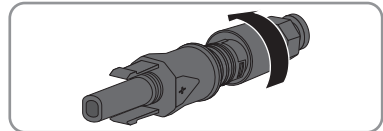

- Insert the DC connectors with sealing plugs into the corresponding DC inputs on the inverter.

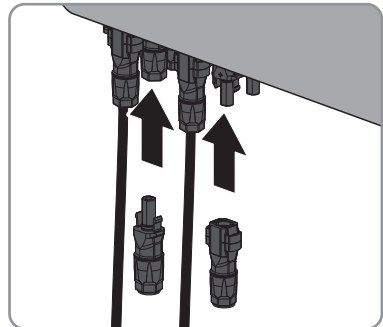

- The DC connectors snap into place.

9. Ensure that all DC connectors are securely in place.

7 Commissioning

7.1 Commissioning Procedure

QUALIFIED PERSON

Before you can commission the inverter, you must check various settings and make changes if necessary. This section describes the procedure and gives an overview of the steps, which must always be performed in the prescribed sequence.

Procedure	See
1. Check which country data set the inverter is set to.	Supplementary sheet with the default settings, type label or display
2. If the country data set is not set correctly for your country or your purpose, adjust to the required country data set and the corresponding display language within the first ten feed-in hours via the rotary switches in the inverter.	Section 7.2, page 42
3. When using BLUETOOTH communication: if the inverter is to communicate with several BLUETOOTH devices, or if BLUETOOTH is not to be used for communication, set the NetID.	Section 7.3, page 43
4. Commission the inverter.	Section 7.4, page 45

7.2 Configuring the Country Data Set

QUALIFIED PERSON

Set the country data set appropriate for your country or purpose within the first ten feed-in hours via the rotary switches in the inverter. After the first ten feed-in hours, the country data set can only be changed by means of a communication product.

A display language is assigned to every country data set. If the display language of the country data set does not match the required language, you can change it after commissioning (see Section 8.2 "Changing the Display Language", page 47).

Procedure:

1. Determine the rotary switch position for your country and purpose. Call up the Technical Information "Overview of the Rotary Switch Settings" at www.SMA-Solar.com.

2. DANGER

Danger to life due to high voltages

- Ensure that the inverter is disconnected from all voltage sources and that the enclosure lid is removed (see Section 10, page 57).

3. Set the rotary switches **A** and **B** to the required position using a flat-blade screwdriver (blade width: 2.5 mm).

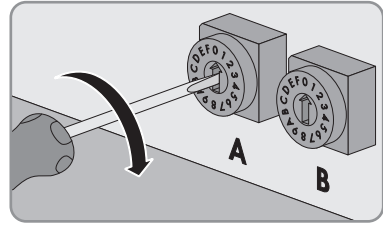

- The inverter will adopt the setting after commissioning. This can take up to five minutes.

7.3 Setting the NetID

⚠ QUALIFIED PERSON

If the inverter is equipped with BLUETOOTH, you can set the NetID of the inverter. By default, the NetID is set to **1** for all SMA inverters and SMA communication products with BLUETOOTH. If your PV system consists of an inverter and a maximum of one further BLUETOOTH device (e.g. computer with BLUETOOTH interface or SMA communication product), you can leave the NetID set to **1**.

You must change the NetID in the following cases:

- If your PV system consists of one inverter and two other BLUETOOTH devices (e.g. computer with BLUETOOTH interface and SMA communication product) or of multiple inverters with BLUETOOTH, you must change the NetID of your PV system. This enables you to communicate using multiple BLUETOOTH devices.
- If another PV system with BLUETOOTH is located within 500 m of your PV system, you must change the NetID of your PV system. This will help keep both PV systems separate.
- If you do not wish to communicate via BLUETOOTH, deactivate the BLUETOOTH communication on your inverter. This will protect your PV system from unauthorized access.

All BLUETOOTH devices in a PV system must have the same NetID. You can set a new NetID in the inverter by means of the rotary switch **C**.

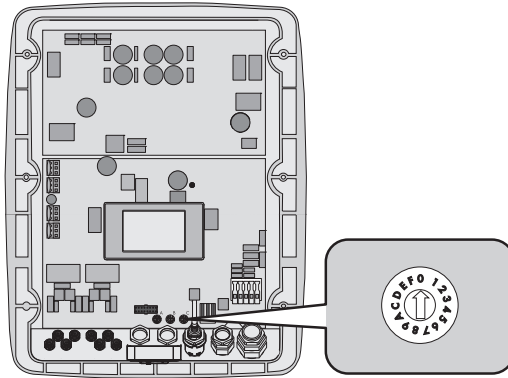

Figure 12: Positions of rotary switch C

Position	Explanation
0	Communication via BLUETOOTH is deactivated.
1	Communication via BLUETOOTH with a further BLUETOOTH device
2 to F	NetID for communication via BLUETOOTH with multiple BLUETOOTH devices

Procedure:

1. **⚠ DANGER**

Danger to life due to high voltages

- Ensure that the inverter is disconnected from all voltage sources (see Section 10, page 57).
2. To set a new NetID, set the rotary switch **C** to the determined NetID using a flat-blade screwdriver (blade width: 2.5 mm).

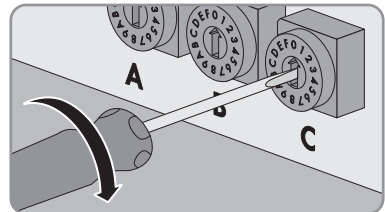

3. To deactivate communication via BLUETOOTH, set the rotary switch **C** to position **O** using a flat-blade screwdriver (blade width: 2.5 mm). This will protect your PV system from unauthorized access.

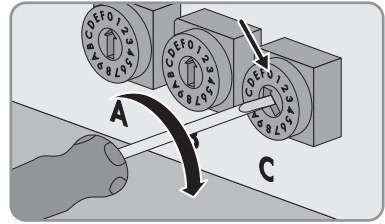

- The inverter will adopt the setting after commissioning. This can take up to five minutes.

7.4 Commissioning the Inverter

⚠ QUALIFIED PERSON

Requirements:

- The inverter must be correctly mounted.
- The circuit breaker must be correctly rated.
- All cables must be correctly connected.
- Unused DC inputs must be sealed using the corresponding DC connectors and sealing plugs.
- The country data set must be set correctly for the country or the purpose.

Procedure:

1. Mount the enclosure lid:
 - Fit one conical spring washer to each screw. The grooved side of the conical spring washer must face the screw head.
 - Position the enclosure lid with the six screws on the enclosure and tighten all screws in the sequence 1 to 6 using an Allen key (AF 5) (torque: $6 \text{ Nm} \pm 0.5 \text{ Nm}$).
 - The teeth of the conical spring washer press into the enclosure lid. This ensures that the enclosure lid is grounded.

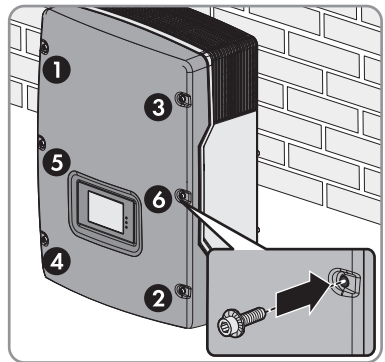
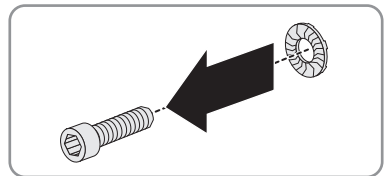

2. Secure the protective cover using two screws and an Allen key (AF 5).
3. Securely plug in the ESS.

4. Switch on the circuit breaker of all three line conductors.
 5. If the multifunction relay is used, switch on any supply voltage to the load.
- All three LEDs start to glow and the start-up phase begins. The start-up phase may take several minutes.
 - The green LED is glowing and the display alternates between the firmware version, the serial number or designation of the inverter, the NetID, the IP address, the subnet mask, the configured country data set and the display language.
 - The green LED is flashing?

Possible cause of error: the DC input voltage is still too low or the inverter is monitoring the utility grid.

- Once the DC input voltage is sufficiently high and the grid-connection conditions are met, the inverter will start operation.
- The red LED is glowing and an error message and event number appear in the display?
 - Rectify the error (see the service manual at www.SMA-Solar.com).

8 Configuration

8.1 Configuration Procedure

Once you have commissioned the inverter, you may have to adjust various settings via the rotary switches in the inverter or via a communication product. This section describes the procedure for configuration and gives an overview of the steps you must perform in the prescribed order.

Procedure	See
1. If the display language is not set correctly, adjust the settings.	Section 8.2, page 47
2. If you want to integrate the inverter into a Speedwire network, connect the inverter to the network.	Section 8.3, page 48
3. Integrate the inverter into the network.	Section 8.4, page 49
4. To manage the PV system data or to set the inverter parameters, capture the inverter in a communication product.	Manual of the communication product at www.SMA-Solar.com
5. Change the system time and system password.	Manual of the communication product at www.SMA-Solar.com
6. If a residual-current device with a tripping threshold of 30 mA was specified and has been installed, set the tripping threshold of the residual-current device.	Section 8.7, page 51
7. If using the multifunction relay, ensure that the operating mode is set correctly and adjust any further settings for the operating mode as necessary.	Section 8.8, page 51
8. For partially shaded PV modules and depending on the given shading situation, you should set the interval at which the inverter optimizes the MPP of the PV system.	Section 8.9, page 52

8.2 Changing the Display Language

QUALIFIED PERSON

If the language for the country data set is not the language you want to use, you can change the display language as follows:

Procedure:

-  **DANGER**

Danger to life due to high voltages

- Disconnect the inverter from all voltage sources and open the enclosure lid (see Section 10, page 57).

2. Determine the rotary switch setting for the desired display language. Call up the Technical Information "Overview of the Rotary Switch Settings" at www.SMA-Solar.com.
3. Set the rotary switch **A** to **0** using a flat-blade screwdriver (blade width: 2.5 mm). This ensures that the selected data country set remains unchanged.

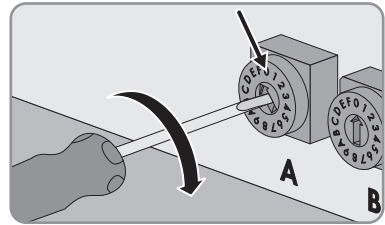

4. Set the rotary switch **B** to the required language using a flat-blade screwdriver (blade width: 2.5 mm).
 5. Recommission the inverter (see service manual at www.SMA-Solar.com).
- The inverter adopts the settings after commissioning. This can take up to five minutes.

8.3 Connecting the Inverter to the Network

⚠ QUALIFIED PERSON

Additionally required material (not included in the scope of delivery):

- One mating plug for RJ45 pin connector in accordance with IEC 61076-3-106, model 4 with push-pull lock
SMA Solar Technology AG recommends the plug sets "STX V4 RJ45" from "Telegärtner" or "IE-PS-V04P-RJ45-FH" from "Weidmüller".
- 1 network cable

Cable requirements:

The cable length and quality affect the quality of the signal. Observe the following cable requirements.

- Cable type: 100BaseTx
- Cable category: Cat5, Cat5e, Cat6, Cat6a or Cat7
- Plug type: RJ45 of Cat5, Cat5e, Cat6 or Cat6a
- Shielding: SF/UTP, S/UTP, SF/FTP or S/FTP
- Number of insulated conductor pairs and insulated conductor cross-section: at least $2 \times 2 \times 0.22 \text{ mm}^2$
- Maximum cable length between two nodes when using patch cables: 50 m
- Maximum cable length between two nodes with installation cable: 100 m
- UV-resistant for outdoor use

Procedure:

1. Connect one end of the network cable to the mating plug (see mating plug documentation).
2. Remove the filler plug from the pin connector for network connection to the inverter.

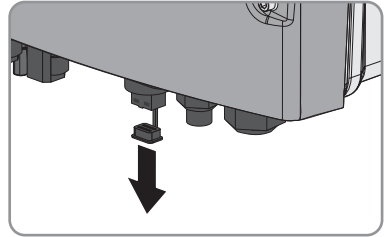

3. Connect the end of the network cable with the mating plug to the inverter. Insert the mating plug firmly into the pin connector on the inverter.
4. Connect the other end of the network cable directly to the computer or router or connect it to another node. You can only connect the inverter to other nodes via star topology.

8.4 Integrating the Inverter into the Network

If the router supports DHCP and DHCP is enabled, the inverter will automatically be integrated into the network. You will not need to carry out network configuration.

If the router does not support DHCP, automatic network configuration will not be possible and you will need to use the SMA Connection Assist to integrate the inverter into the network.

Requirements:

- The inverter must be in operation.
- There must be a router with Internet connection in the local network of the system.
- The inverter must be connected to the router.

Procedure:

- Integrate the inverter into the network by means of the SMA Connection Assist. Download the SMA Connection Assist and install it on the computer (see www.SMA-Solar.com).

8.5 Changing Operating Parameters

This section describes the basic procedure for changing operating parameters. Always change operating parameters as described in this section. Some parameters that have sensitive functions can only be viewed and changed by qualified persons (for further information on changing parameters, refer to the manual of the communication product).

The operating parameters of the inverter are set to certain values by default. To optimize inverter operation, you can change the operating parameters using a communication product.

Requirements:

- Depending on the type of communication, a computer with BLUETOOTH or Ethernet interface must be available.
- A communication product corresponding to the type of communication used must be available.

- The inverter must be registered in the communication product.
- The changes to the grid-relevant parameters must be approved by the responsible grid operator.
- When changing grid-relevant parameters, the SMA Grid Guard code must be available (see "Application for SMA Grid Guard Code" at www.SMA-Solar.com).

Procedure:

1. Call up the user interface of the communication product or software and log in as **Installer** or **User**.
2. If required, enter the SMA Grid Guard code.
3. Select and set the required parameter.
4. Save settings.

8.6 Configuring the Modbus Function

QUALIFIED PERSON

The Modbus interface is deactivated by default and the communication ports 502 set. In order to access SMA inverters with SMA Modbus® or SunSpec® Modbus®, the Modbus interface must be activated. After activating the interface, the communication ports of both IP protocols can be changed.

For information on commissioning and configuration of the Modbus interface, see the Technical Information "SMA Modbus® Interface" or in the Technical Information "SunSpec® Modbus® Interface" at www.SMA-Solar.com.

Data security during activated Modbus interface

If you activate the Modbus interface, there is a risk that unauthorized users may access and manipulate the data or devices in your PV system.

- Take appropriate protective measures such as:
 - Set up a firewall.
 - Close unnecessary network ports.
 - Only enable remote access via VPN tunnel.
 - Do not set up port forwarding at the communication port in use.
 - In order to deactivate the Modbus interface, reset the inverter to default settings or deactivate the activated parameter again.

Procedure:

- Activate the Modbus interface and adjust the communication ports if necessary (see the Technical Information "SMA Modbus® Interface" or "SunSpec® Modbus® Interface" at www.SMA-Solar.com).

8.7 Setting the Tripping Threshold of the Residual-Current Device

⚠ QUALIFIED PERSON

If a residual-current device with a tripping threshold of 30 mA is specified and installed, you must set the parameter **RCD adjustment** to **30 mA** (for further information, see the Technical Information ""Leading Leakage Currents"" at www.SMA-Solar.com).

The basic procedure for changing operating parameters is explained in another section (see Section 8.5 "Changing Operating Parameters", page 49).

- Select the parameter **RCD adjustment** and set it to **30 mA**.

8.8 Changing the Operating Mode of the Multifunction Relay

⚠ QUALIFIED PERSON

The default operating mode of the multifunction relay is **Fault indication (FltInd)**. If you decide to use another operating mode and have established the correct electrical connection for this operating mode and the associated connection variant, you will have to change the operating mode of the multifunction relay and make other settings, if necessary.

The basic procedure for changing operating parameters is explained in another section (see Section 8.5 "Changing Operating Parameters", page 49).

Procedure:

1. Select the parameter **Operating mode of multifunction relay** or **Mlt.OpMode** and set the desired operating mode.
2. Once you have set the operating mode **Self-consumption** or **SelfCsmP**, you can configure other settings:
 - Select the parameter **Minimum On power for MFR self-consumption** or **Mlt.MinOnPwr** and set the desired value. This will configure the power threshold from which a load is to be activated.
 - Select the parameter **Minimum power On time, MFR self-consumption** or **Mlt.MinOnPwrTmm** and set the desired value. This will configure the minimum time for which the power must have exceeded the minimum switch-on power threshold in order to trip activation of the load.
 - Select the parameter **Minimum On time for MFR self-consumption** or **Mlt.MinOnTmm** and set the desired value. This will configure the minimum time for which the load remains activated.
3. If you have set the operating mode **Control via communication** or **ComCtl**, select the parameter **Status of MFR with control via communication** or **Mlt.ComCtl.Sw** and set the desired value. This will configure the status at which the multifunction relay is controlled via a communication product.
4. If you have set the operating mode **Battery bank** or **BatCha**, make further settings:

- Select the parameter **Minimum On power for MFR battery bank** or **Mlt.BatCha.Pwr** and set the desired value. This will configure the power threshold from which the battery is to be charged.
- Select the parameter **Minimum time before reconnection of MFR battery bank** or **Mlt.BatCha.Tmm** and set the desired value. This will configure the minimum time which must elapse after charging the battery before the battery can be charged again.

8.9 Setting SMA OptiTrac Global Peak

QUALIFIED PERSON

For partially shaded PV modules, you should set the interval at which the inverter is to optimize the MPP of the PV system. If you do not want to use SMA OptiTrac Global Peak feature, you can deactivate the feature.

The basic procedure for changing operating parameters is explained in another section (see Section 8.5 "Changing Operating Parameters", page 49).

Procedure:

- Select the parameter **Cycle time of the OptiTrac Global Peak algorithm** or **MPPShdw.CycTms** and set the required time interval. The ideal time interval is usually six minutes. This value should only be increased if the shading situation changes extremely slowly.
 - The inverter optimizes the MPP of the PV system at the predetermined time interval.
- In order to deactivate the SMA OptiTrac Global Peak feature, select the parameter **OptiTrac Global Peak switched on** or set **MPPShdw.IsOn** to **Off**.

9 Operation

9.1 LED Signals

The LEDs indicate the operating state of the inverter.

LED	Status	Explanation
Green LED	glowing	Feed-in operation If an event occurs during feed-in operation, an event message will be shown on the display (for event messages see the service manual at www.SMA-Solar.com).
	flashing	The conditions for feed-in operation are not yet met. As soon as the conditions are met, the inverter will start feed-in operation.
Red LED	glowing	Error If an error occurs, the error message and the corresponding event number will be shown in the display. The error must be rectified by a qualified person (for troubleshooting, see the service manual at www.SMA-Solar.com).
Blue LED	glowing	For inverters including BLUETOOTH as standard equipment: BLUETOOTH communication is activated.

9.2 Display Overview

The display shows the current operating data of the inverter (e.g. current power, daily energy, total energy) as well as events or errors. Power and energy are displayed as bars in a diagram.

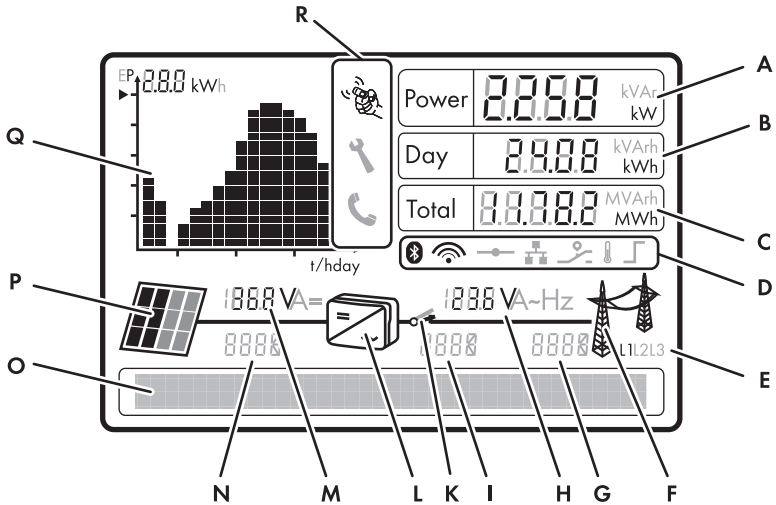









Figure 13: Layout of the display (example)

Position	Symbol	Explanation
A	-	Current power
B	-	Energy on the current day
C	-	Total amount of energy fed in
D		In inverters with BLUETOOTH: active BLUETOOTH connection
		In inverters with BLUETOOTH: strength of BLUETOOTH signal
		Active connection to a Speedwire network
		Active connection to Sunny Portal
		Multifunction relay is active
		Power limitation due to excessive temperature
		Active power limitation via PV system control
E	-	Line conductor to which the displayed values apply

Position	Symbol	Explanation
F		Utility grid
G	-	Event number of an error on the utility grid side
H	-	Output voltage or output current of a line conductor
I	-	Event number of an error in the inverter
K		Grid relay When the grid relay is closed, the inverter feeds into the utility grid. When the grid relay is open, the inverter is disconnected from the utility grid.
L		Inverter
M	-	Input voltage or input current of a line conductor
N	-	Event number of an error on the PV array side
O	-	Text line to display event and error messages
P		PV array
Q	-	Diagram with the power curve of the last 16 feed-in hours or energy yields of the last 16 days <ul style="list-style-type: none"> In order to switch between diagrams, tap once on the enclosure lid.
R		You can operate the display by tapping on the enclosure lid (see Section 9.3, page 55).
		The displayed error must be rectified on-site by a qualified person (for troubleshooting, see service manual at www.SMA-Solar.com).
		The displayed error cannot be rectified on-site. <ul style="list-style-type: none"> Contact the Service (see Section 13, page 70).

9.3 Activating and Operating the Display

You can activate and operate the display by tapping on the enclosure lid.

Procedure:

1. Activate the display. Tap on the enclosure lid once.

- The backlight is switched on.

2. To move to the next line, tap on the enclosure lid once.
3. In order to switch between the power curve of the last 16 feed-in hours and the energy yields of the last 16 days in the diagram, tap on the enclosure lid once.

9.4 Calling Up Display Messages of the Start-Up Phase

Various inverter information is displayed during the start-up phase that can be called up whenever required during operation.

Procedure:

- Tap on the enclosure lid twice.
 - The display shows all messages of the start-up phase in sequence.

10 Disconnecting the Inverter from Voltage Sources

⚠ QUALIFIED PERSON

Prior to performing any work on the inverter, always disconnect it from all voltage sources as described in this section. Always adhere to the prescribed sequence.

NOTICE

Destruction of the measuring device due to overvoltage

- Only use measuring devices with a DC input voltage range of 1000 V or higher.

Procedure:

1. Disconnect the circuit breaker from all three line conductors and secure against reconnection.
2. Remove the ESS.
3. Loosen two screws of the protective cover using an Allen key (AF 5) and remove the protective cover.
4. Use a current clamp to ensure that no current is present in the DC cables.
5. Release and remove all DC connectors. To do this, insert a flat-blade screwdriver or an angled screwdriver (blade width: 3.5 mm) into one of the side slots and pull the DC connectors straight out. Do not pull on the cable.

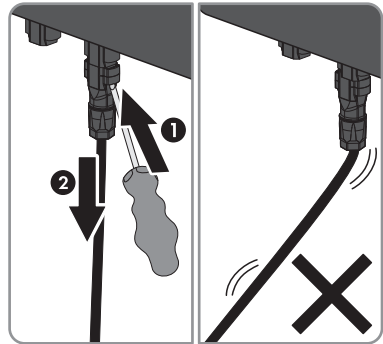

6. ⚠ DANGER

Danger to life due to high voltages

The capacitors in the inverter take five minutes to discharge.

- Wait five minutes before opening the enclosure lid.

7. Ensure that no voltage is present at the DC inputs of the inverter.
8. Unscrew all the screws of the enclosure lid using an Allen key (AF 5) and remove the enclosure lid.
9. Use an appropriate measuring device to ensure that no voltage is present at the AC connecting terminal plate between **L1** and **N**, **L2** and **N**, and **L3** and **N**. Insert the test probe into each round opening of the terminal.

10. Use an appropriate measuring device to ensure that no voltage is present at the AC connecting terminal plate between **L1** and **PE**, **L2** and **PE**, and **L3** and **PE**. Insert the test probe into each round opening of the terminal.
11. Ensure that no voltage is present between any terminal of the multifunction relay and **PE** of the AC connecting terminal plate.

12.

NOTICE

Damage to the inverter due to electrostatic discharge

The internal components of the inverter can be irreparably damaged by electrostatic discharge.

- Ground yourself before touching any component.

11 Technical Data

11.1 DC/AC

11.1.1 Sunny Tripower 5000TL / 6000TL / 7000TL

DC Input

	STP 5000TL-20	STP 6000TL-20	STP 7000TL-20
Maximum DC power at $\cos \varphi = 1$	5100 W	6125 W	7175 W
Maximum input voltage	1000 V	1000 V	1000 V
MPP voltage range	245 V to 800 V	295 V to 800 V	290 V to 800 V
Rated input voltage	580 V	580 V	580 V
Minimum usable input voltage	150 V	150 V	150 V
Initial input voltage	188 V	188 V	188 V
Maximum input current, input A	11 A	11 A	15 A
Maximum input current, input B	10 A	10 A	10 A
Maximum input current per string, input A	11 A	11 A	15 A
Maximum input current per string, input B	10 A	10 A	10 A
Maximum short-circuit current, input A*	17 A	17 A	25 A
Maximum short-circuit current, input B*	15 A	15 A	15 A
Maximum reverse current from the inverter in the system for max. 1 ms	0 A	0 A	0 A
Number of independent MPP inputs	2	2	2
Strings per MPP input	2	2	2
Overvoltage category in accordance with IEC 60664-1	II	II	II

* In accordance with IEC 62109-2: ISC PV

AC Output

	STP 5000TL-20	STP 6000TL-20	STP 7000TL-20
Rated power at 230 V, 50 Hz	5000 W	6000 W	7000 W
Maximum apparent AC power at $\cos \phi = 1$	5000 VA	6000 VA	7000 VA
Rated grid voltage	~3/N/PE, 230 V / 400 V	~3/N/PE, 230 V / 400 V	~3/N/PE, 230 V / 400 V
AC voltage range*	160 V to 280 V	160 V to 280 V	160 V to 280 V
Nominal AC current at 220 V	7.3 A	8.7 A	10.2 A
Nominal AC current at 230 V	7.3 A	8.7 A	10.2 A
Nominal AC current at 240 V	6.9 A	8.3 A	10.1 A
Maximum output current	7.3 A	8.7 A	10.2 A
Total harmonic distortion of the output current with total harmonic distortion of the AC voltage < 2%, and AC power > 50% of the rated power	≤3 %	≤3 %	≤3 %
Maximum output current under fault conditions	12 A	15 A	17 A
Rated power frequency	50 Hz	50 Hz	50 Hz
AC power frequency*	50 Hz / 60 Hz	50 Hz / 60 Hz	50 Hz / 60 Hz
Operating range at AC power frequency 50 Hz	45.5 Hz to 54.5 Hz	45.5 Hz to 54.5 Hz	45.5 Hz to 54.5 Hz
Operating range at AC power frequency 60 Hz	55.5 Hz to 64.5 Hz	55.5 Hz to 64.5 Hz	55.5 Hz to 64.5 Hz
Displacement power factor $\cos \phi$, adjustable	0.8 underexcited to 1 to 0.8 overexcited	0.8 underexcited to 1 to 0.8 overexcited	0.8 underexcited to 1 to 0.8 overexcited
Feed-in phases	3	3	3
Phase connection	3	3	3
Overvoltage category in accordance with IEC 60664-1	III	III	III

* depending on the configured country data set

Efficiency

	STP 5000TL-20	STP 6000TL-20	STP 7000TL-20
Maximum efficiency, η_{\max}	98 %	98 %	98 %
European weighted efficiency, η_{EU}	97.1 %	97.4 %	97.5 %

11.1.2 Sunny Tripower 8000TL / 9000TL / 10000TL

DC Input

	STP 8000TL-20	STP 9000TL-20	STP 10000TL-20
Maximum DC power at $\cos \varphi = 1$	8200 W	9225 W	10250 W
Maximum input voltage	1000 V	1000 V	1000 V
MPP voltage range	330 V to 800 V	370 V to 800 V	370 V to 800 V
Rated input voltage	580 V	580 V	580 V
Minimum usable input voltage	150 V	150 V	150 V
Initial input voltage	188 V	188 V	188 V
Maximum input current, input A	15 A	15 A	18 A
Maximum input current, input B	10 A	10 A	10 A
Maximum input current per string, input A	15 A	15 A	18 A
Maximum input current per string, input B	10 A	10 A	10 A
Maximum short-circuit current, input A*	25 A	25 A	25 A
Maximum short-circuit current, input B*	15 A	15 A	15 A
Maximum reverse current from the inverter in the system for max. 1 ms	0 A	0 A	0 A
Number of independent MPP inputs	2	2	2
Strings per MPP input	2	2	2
Overvoltage category in accordance with IEC 60664-1	II	II	II

* In accordance with IEC 62109-2: ISC PV

AC Output

	STP 8000TL-20	STP 9000TL-20	STP 10000TL-20
Rated power at 230 V, 50 Hz	8000 W	9000 W	10000 W
Maximum apparent AC power at $\cos \varphi = 1$	8000 VA	9000 VA	10000 VA
Rated grid voltage	~3/N/PE, 230 V / 400 V	~3/N/PE, 230 V / 400 V	~3/N/PE, 230 V / 400 V
AC voltage range*	160 V to 280 V	160 V to 280 V	160 V to 280 V
Nominal AC current at 220 V	11.6 A	13.1 A	14.5 A
Nominal AC current at 230 V	11.6 A	13.1 A	14.5 A
Nominal AC current at 240 V	11.1 A	12.5 A	13.9 A
Maximum output current	11.6 A	13.1 A	14.5 A
Total harmonic distortion of the output current with total harmonic distortion of the AC voltage < 2%, and AC power > 50% of the rated power	≤3 %	≤3 %	≤3 %
Maximum output current under fault conditions	20 A	22 A	25 A
Rated power frequency	50 Hz	50 Hz	50 Hz
AC power frequency*	50 Hz / 60 Hz	50 Hz / 60 Hz	50 Hz / 60 Hz
Operating range at AC power frequency 50 Hz	45.5 Hz to 54.5 Hz	45.5 Hz to 54.5 Hz	45.5 Hz to 54.5 Hz
Operating range at AC power frequency 60 Hz	55.5 Hz to 64.5 Hz	55.5 Hz to 64.5 Hz	55.5 Hz to 64.5 Hz
Displacement power factor $\cos \varphi$, adjustable	0.8 underexcited to 1 to 0.8 overexcited	0.8 underexcited to 1 to 0.8 overexcited	0.8 underexcited to 1 to 0.8 overexcited
Feed-in phases	3	3	3
Phase connection	3	3	3
Overvoltage category in accordance with IEC 60664-1	III	III	III

* depending on the configured country data set

Efficiency

	STP 8000TL-20	STP 9000TL-20	STP 10000TL-20
Maximum efficiency, η_{\max}	98 %	98 %	98 %
European weighted efficiency, η_{EU}	97.6 %	97.6 %	97.6 %

11.1.3 Sunny Tripower 12000TL

DC Input

	STP 12000TL-20
Maximum DC power at $\cos \varphi = 1$	12275 W
Maximum input voltage	1000 V
MPP voltage range	440 V to 800 V
Rated input voltage	580 V
Minimum usable input voltage	150 V
Initial input voltage	188 V
Maximum input current, input A	18 A
Maximum input current, input B	10 A
Maximum input current per string, input A	18 A
Maximum input current per string, input B	10 A
Maximum short-circuit current, input A*	25 A
Maximum short-circuit current, input B*	15 A
Maximum reverse current from the inverter in the system for max. 1 ms	0 A
Number of independent MPP inputs	2
Strings per MPP input	2
Overvoltage category in accordance with IEC 60664-1	II

* In accordance with IEC 62109-2: ISC PV

AC Output

	STP 12000TL-20
Rated power at 230 V, 50 Hz	12000 W
Maximum apparent AC power at $\cos \varphi = 1$	12000 VA
Rated grid voltage	~3/N/PE, 230 V / 400 V
AC voltage range*	160 V to 280 V
Nominal AC current at 220 V	17.4 A

	STP 12000TL-20
Nominal AC current at 230 V	17.4 A
Nominal AC current at 240 V	16.7 A
Maximum output current	17.4 A
Total harmonic distortion of the output current with total harmonic distortion of the AC voltage < 2%, and AC power > 50% of the rated power	≤3 %
Maximum output current under fault conditions	30 A
Rated power frequency	50 Hz
AC power frequency*	50 Hz / 60 Hz
Operating range at AC power frequency 50 Hz	45.5 Hz to 54.5 Hz
Operating range at AC power frequency 60 Hz	55.5 Hz to 64.5 Hz
Displacement power factor $\cos \varphi$, adjustable	0.8 underexcited to 1 to 0.8 overexcited
Feed-in phases	3
Phase connection	3
Overvoltage category in accordance with IEC 60664-1	III

* depending on the configured country data set

Efficiency

	STP 12000TL-20
Maximum efficiency, η_{\max}	98.2 %
European weighted efficiency, η_{EU}	97.9 %

11.2 General Data

Width x height x depth, with Electronic Solar Switch	470 mm x 730 mm x 240 mm
Weight of STP 5000TL-20 / 6000TL-20 / 7000TL-20 / 8000TL-20 / 9000TL-20 / 10000TL-20	37 kg
Weight of STP 12000TL-20	38 kg
Length x width x height of the packaging	798 mm x 598 mm x 398 mm
Transport weight of STP 5000TL-20 / 6000TL-20 / 7000TL-20 / 8000TL-20 / 9000TL-20 / 10000TL-20	40 kg
Transport weight of STP 12000TL-20	41 kg

Climatic category in accordance with IEC 60721-3-4	4K4H
Environmental category	Outdoors
Pollution degree outside the enclosure	3
Pollution degree inside the enclosure	2
Operating temperature range	-25 °C to +60 °C
Maximum permissible value for relative humidity, non-condensing	100 %
Maximum operating altitude above mean sea level (MSL)	3000 m
Typical noise emission	≤40 dB(A)
Power loss in night mode	1 W
Maximum data volume per inverter with Speedwire/Webconnect	550 MB/month
Additional data volume when using the Sunny Portal live interface	600 kB/hour
Topology	Transformerless
Cooling method	SMA OptiCool
Fan connection	Designed for safe disconnection in accordance with DIN EN 62109
Degree of protection for electronics in accordance with IEC 60529	IP65
Protection class in accordance with IEC 61140	I

Grid configurations	TN-C, TN-S, TN-C-S, TT (when $V_{N,PE} < 20 \text{ V}$)
Approvals and national standards, as per 06/2017*	AS 4777.2:2015, AS 4777.3, CE, CEI 0-21:2016, C10/11:2012, DIN EN 62109-1, EN 50438, G59/3, G83/2, IEC 61727/MEA, IEC 62109-2, NEN EN 50438, NRS 097-2-1, PPC, PPDS, RD 661/2007, RD 1699:2011, SI 4777, UTE C15-712-1, VDE0126-1-1, VDE-AR-N 4105, VFR 2013, VFR 2014

* **AS 4777.3:** If DRM support is specified, the inverter may only be used in conjunction with a Demand Response Enabling Device (DRED).

CEI 0-21: only permitted with external decoupling protection.

C10/11:2012: only possible if the three-phase line-to-line voltage is 400 V.

IEC 61727/MEA: applies only to the STP 9000TL-20.

EN 50438: does not apply to all national appendices of EN 50438.

IEC 62109-2: This standard requires that either the multifunction relay in the inverter is used as fault indicator or that the inverter is connected to Sunny Portal and that the fault alert is activated in Sunny Portal.

NRS 97-2-1: This standard requires a separate label be attached to the AC distribution board to indicate the AC-side disconnection of the inverter in case of a grid failure (for further details, see NRS 97-2-1, Sect. 4.2.7.1 and 4.2.7.2).

11.3 Protective Devices

DC reverse polarity protection	Short-circuit diode
Input-side disconnection point	Electronic Solar Switch, SUNCLIX DC connector
AC short-circuit current capability	Current control
Grid monitoring	SMA Grid Guard 4
Maximum permissible fuse protection	32 A
Ground-fault monitoring for STP 5000TL-20 / 6000TL-20 / 7000TL-20 / 8000TL-20 / 9000TL-20	Insulation monitoring: $R_{iso} > 385 \text{ k}\Omega$
Ground-fault monitoring for STP 10000TL-20 / 12000TL-20	Insulation monitoring: $R_{iso} > 200 \text{ k}\Omega$
All-pole sensitive residual-current monitoring unit	Available
Grounding conductor monitoring	Available

11.4 Climatic Conditions

Installation in accordance with IEC 60721-3-3, Class 4K4H

Extended temperature range	-25 °C to +60 °C
----------------------------	------------------

Extended humidity range	0% to 100%
Extended air pressure range	79.5 kPa to 106 kPa

Transport in accordance with IEC 60721-3-2, Class 2K3

Temperature range	-25 °C to +70 °C
-------------------	------------------

11.5 Equipment

DC connection	SUNCLIX DC connector
AC-Anschluss	Spring-cage terminal
Display	LC graphic display
BLUETOOTH	As standard*
Speedwire/Webconnect interface	As standard
Multi-function relay	As standard
SMA Power Control Module	Optional
RS485 Interface	Optional

* Depending on date of manufacture

11.6 Torques

Enclosure lid screws	6.0 Nm ± 0.5 Nm
Protective cover screws	2.0 Nm
Additional grounding	6.0 Nm
Cylindrical screw for attaching the enclosure to the wall mounting bracket	6.0 Nm
SUNCLIX swivel nut	2.0 Nm

11.7 Multifunction Relay

Maximum AC switching voltage	240 V
Maximum DC switching voltage	30 V
Maximum AC switching current	1.0 A
Maximum DC switching current	1.0 A
Minimum electrical endurance when the maximum switching voltage and maximum switching current are complied with*	100000 switching cycles

* Corresponds to 20 years at 12 switching operations per day

11.8 Electronic Solar Switch

Electrical endurance in the event of short circuit,
at nominal current of 30 A

At least 50 switching operations

Maximum switching current	30 A
Maximum switching voltage	1000 V
Maximum power	12 kW
Degree of protection when plugged in	IP65
Degree of protection when unplugged	IP65
Fuses for Electronic Solar Switch	2 x 1000 V / 4 A, fast acting (soldered, non-replaceable)

11.9 Data Storage Capacity

Energy yields in the course of the day	63 days
Daily yields	30 years
Event messages for users	250 events
Event messages for installers	250 events

12 Accessories

You will find the accessories for your product in the following overview. If required, these can be ordered from SMA Solar Technology AG or your distributor.

Designation	Brief description	SMA order number
SMA Power Control Module	Multifunction interface for implementing grid management systems for one inverter	PWCBRD-10
RS485 data module	RS485 interface as retrofit kit	485BRD-10

13 Contact

If you have technical problems with our products, please contact the SMA Service Line. We require the following information in order to provide you with the necessary assistance:

- Inverter device type
- Inverter serial number
- Inverter firmware version
- Special country-specific settings of the inverter (if applicable)
- Type and number of PV modules connected
- Mounting location and altitude of the inverter
- Inverter message
- Optional equipment, e.g. communication products
- If necessary, system name in the Sunny Portal
- If necessary, access data in the Sunny Portal
- Operating mode of the multifunction relay

Danmark	SMA Solar Technology AG	Belgien	SMA Benelux BVBA/SPRL
Deutschland	Niestetal	Belgique	Mechelen
Österreich	Sunny Boy, Sunny Mini Central,	België	+32 15 286 730
Schweiz	Sunny Tripower: +49 561 9522-1499	Luxemburg	SMA Online Service Center: www.SMA-Service.com
	Monitoring Systems (Kommunikationsprodukte): +49 561 9522-2499	Luxembourg	
	Fuel Save Controller (PV-Diesel-Hybridsysteme): +49 561 9522-3199	Nederland	
	Sunny Island, Sunny Boy Storage, Sunny Backup, Hydro Boy: +49 561 9522-399	Česko	SMA Service Partner
	Sunny Central, Sunny Central Storage: +49 561 9522-299	Magyarország	TERMS a.s. +420 387 6 85 111
	SMA Online Service Center: www.SMA-Service.com	Slovensko	SMA Online Service Center: www.SMA-Service.com
		Türkiye	SMA Service Partner DEKOM Ltd. Şti. +90 24 22430605 SMA Online Service Center: www.SMA-Service.com

France	SMA France S.A.S. Lyon +33 472 22 97 00 SMA Online Service Center : www.SMA-Service.com	Ελλάδα Κύπρος	SMA Service Partner AKTOR FM. Αθήνα +30 210 8184550 SMA Online Service Center: www.SMA-Service.com
España Portugal	SMA Ibérica Tecnología Solar, S.L.U. Barcelona +34 935 63 50 99 SMA Online Service Center: www.SMA-Service.com	United Kingdom	SMA Solar UK Ltd. Milton Keynes +44 1908 304899 SMA Online Service Center: www.SMA-Service.com
Italia	SMA Italia S.r.l. Milano +39 02 8934-7299 SMA Online Service Center: www.SMA-Service.com	Bulgaria România Slovenija Hrvatska	SMA Service Partner Renovatio Solar +40 372 756 599 SMA Online Service Center: www.SMA-Service.com
United Arab Emirates	SMA Middle East LLC Abu Dhabi +971 2234 6177 SMA Online Service Center: www.SMA-Service.com	India	SMA Solar India Pvt. Ltd. Mumbai +91 22 61713888
ไทย	SMA Solar (Thailand) Co., Ltd. ประเทศไทย +66 2 670 6999	대한민국	SMA Technology Korea Co., Ltd. 서울 +82-2-520-2666

South Africa	SMA Solar Technology South Africa Pty Ltd. Cape Town 08600SUNNY (08600 78669) International: +27 (0)21 826 0600 SMA Online Service Center: www.SMA-Service.com	Argentina Brasil Chile Perú	SMA South America SPA Santiago de Chile +562 2820 2101
Australia	SMA Australia Pty Ltd. Sydney Toll free for Australia: 1800 SMA AUS (1800 762 287) International: +61 2 9491 4200	Other countries	International SMA Service Line Niestetal 00800 SMA SERVICE (+800 762 7378423)

14 EU Declaration of Conformity

within the meaning of the EU directives

- Electromagnetic compatibility 2014/30/EU (29.3.2014 L 96/79-106) (EMC)
- Low Voltage Directive 2014/35/EU (29.3.2014 L 96/357-374) (LVD)



SMA Solar Technology AG confirms herewith that the inverters described in this document are in compliance with the fundamental requirements and other relevant provisions of the above-mentioned directives. The entire EU Declaration of Conformity can be found at www.SMA-Solar.com.

