

# SMA Bluetooth

SMA Bluetooth<sup>®</sup> Wireless Technology in Practice

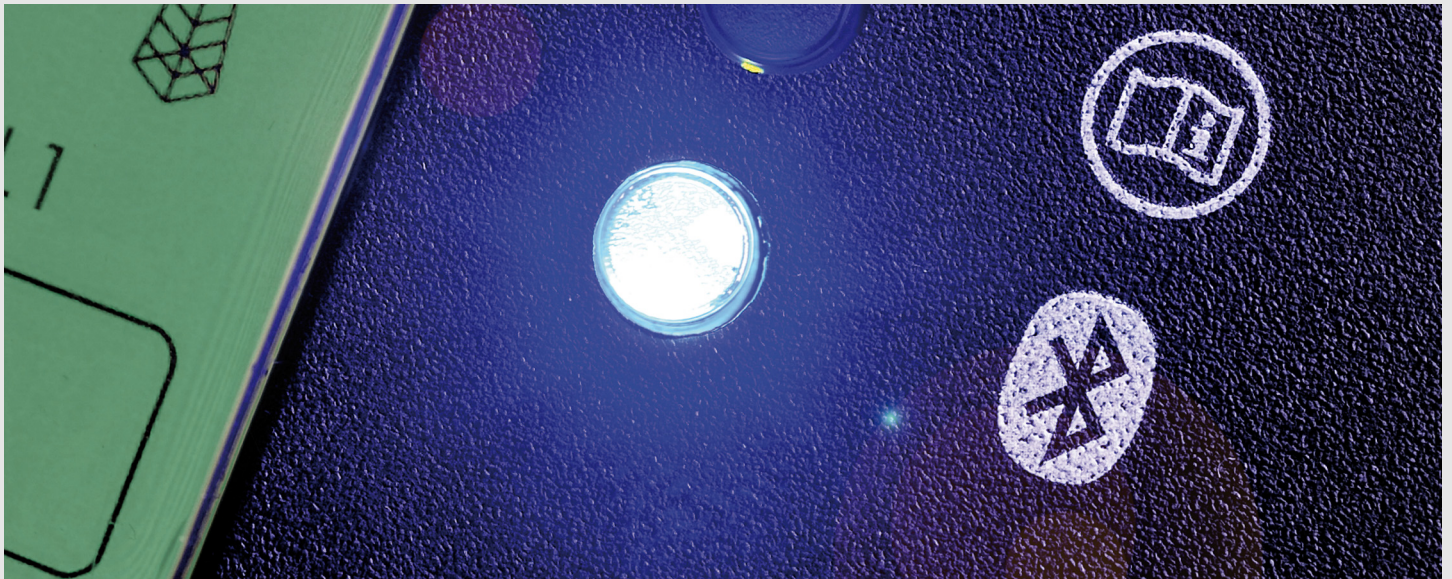

## Content

---

This document summarises the main features of *SMA Bluetooth* Wireless Technology and provides answers to questions from practice.

### **Further Documents on *SMA Bluetooth***

The technical description "*SMA Bluetooth* Wireless Technology" is available at [www.SMA.de/en](http://www.SMA.de/en) in the download area of *Bluetooth* products.

# 1 RS485 and *Bluetooth* Compared

SMA Solar Technology AG provides wired and wireless communication for PV plants. What type is suitable for your PV plant depends on your preference, the size of your PV plant and the distance between the devices.

The following table provides a brief overview of the differences between wired (RS485) and wireless (*Bluetooth*) communication from SMA Solar Technology AG.

	<b>Wired: RS485</b>	<b>Wireless: <i>Bluetooth</i></b>
<b>Typical application</b>	Medium and large PV plants	Especially small and medium PV plants
<b>Benefits</b>	High speed and reliability	Reduced costs and effort
<b>Number of nodes (PV plant monitoring and inverters)</b>	Up to 50 per RS485 bus	Up to 50 per <i>Bluetooth</i> network (inverter and SMA <i>Bluetooth</i> Repeater)
<b>Number of data capture devices</b> (for example, Sunny Beam, Sunny WebBox)	1 device per RS485 bus	Up to 4 devices per <i>Bluetooth</i> network (depending on the number of nodes)
<b>Range</b>	1,200 m per RS485 bus	Up to 100 m in the open air between individual devices
<b>Possibility for feed-in and grid management</b>	Power Reducer Box from SMA Solar Technology AG	Power Reducer Box from SMA Solar Technology AG

## 2 SMA Bluetooth

---

### 2.1 Range

SMA Bluetooth has a range of up to 100 m in free-field conditions with direct visual contact. In free field-conditions with direct visual contact the SMA Bluetooth Piggy-Back, used for retrofitting SMA inverters with Bluetooth, achieves a radio range of up to 50 m because of the inverter enclosure.

The range depends on various influencing factors, which are partly manipulable. The following factors can influence the range:

- Damping obstacles

Since the devices do not often stand in direct visual contact, the radio signals must penetrate ceilings, walls and doors, for example. As a result of these obstacles, the radio signals are weakened to various extents (damped). To what extent an obstacle damps the radio signals depends on the thickness and material of the obstacle.

- Changing conditions

Changing conditions are changes that can occur during operation of the Bluetooth network, such as occasionally parked vehicles or temporarily closed gates.

- Reflections

Radio waves that hit obstacles and are deflected from there in a different direction are called reflections. They cause radio signals to take multiple paths to reach the receiver or not to reach it at all. Depending on the local conditions, reflections can lead to the receiving conditions appearing to be better or worse than assumed when purely considering the damping effects.

- Transmission power

The transmission power of the Bluetooth node with the lower transmission power limits the possible distance between two Bluetooth nodes. If, for example, a node has a radio range of 100 m and the other nodes a radio range of 10 m, the nodes may not be more than 10 m apart.

- Receiver sensitivity

The receiver sensitivity is a measure of the minimum strength the radio signals must have in order that they can be received without errors. The more sensitive the device is set, the weaker the radio signals can be which the device still can perfectly receive. The receiver sensitivity depends on the hardware and software of a device.

The following table shows the transmission power of SMA devices with *Bluetooth* in free-field conditions in case of direct visual contact. The illustrated power applies to both transmitting and receiving of *Bluetooth* radio signals.

The table is to serve as a reference when designing your PV plant. SMA Solar Technology AG has tested the transmission power of all the devices listed in the table. The transmission power of devices not listed in the table has not been tested. You can assume a comparable transmission power for devices that have not been tested but are equipped with an enclosure corresponding to one of those shown in the table.

For devices that have not been tested with SMA *Bluetooth* Piggy-Back Plus, you can assume a similar or better transmission power than the transmission power of the SMC 6000TL with SMA *Bluetooth* Piggy-Back Plus.

When designing your plant, take the following factors into account:

- The range depends on various influencing factors (see p. 3).
- In order to determine the maximum distance between two *Bluetooth* nodes, the transmission power of both of them must be taken into account. The transmission power of the *Bluetooth* node with the lower transmission power is decisive.
- Depending on the enclosure side, the transmission power of the *Bluetooth* node may vary. It is therefore important to consider the orientation of a *Bluetooth* node towards others.

#### Legend:

⊕⊕⊕ = optimum transmission power

⊕⊕⊕ = good transmission power

⊕⊕⊕ = moderate transmission power

⊕⊕⊕ = low transmission power

#### Devices with "moderate" and "low" transmission power

SMA Solar Technology AG recommends equipping devices with mainly "moderate" or "low" transmission power with an SMA *Bluetooth* Repeater, an SMA *Bluetooth* Repeater Outdoor or an SMA *Bluetooth* Piggy-Back Plus.

**Inverters with Integrated Bluetooth**

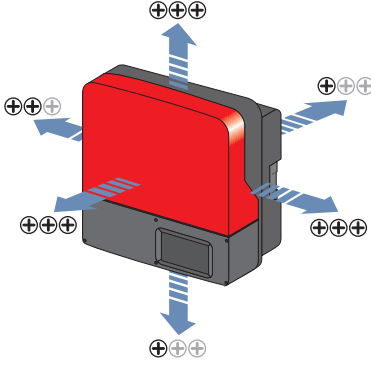
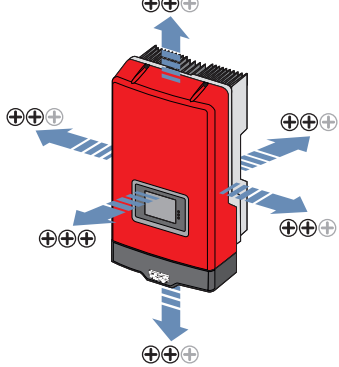
<p><b>Tested devices</b> (SB = Sunny Boy, SMC = Sunny Mini Central)</p>	<p><b>Transmission power, depending on the enclosure side</b></p>	<p><b>Untested devices with comparable transmission power</b>  (SB = Sunny Boy, SMC = Sunny Mini Central, WB = Windy Boy)</p>
<ul style="list-style-type: none"> <li>• SB 5000TL-20</li> </ul>		<p><b>PV inverters:</b></p> <ul style="list-style-type: none"> <li>- SB 3000TL-20, SB 4000TL-20</li> </ul> <p><b>Wind power inverters:</b></p> <ul style="list-style-type: none"> <li>- WB 3600TL-20, WB 5000TL-20</li> </ul>
<ul style="list-style-type: none"> <li>• SB 3000HF-30</li> </ul>		<p><b>PV inverters:</b></p> <ul style="list-style-type: none"> <li>- SB 2000HF-30, SB 2500HF-30</li> </ul>

### Inverters with SMA Bluetooth Piggy-Back

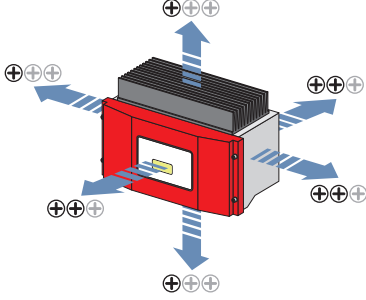
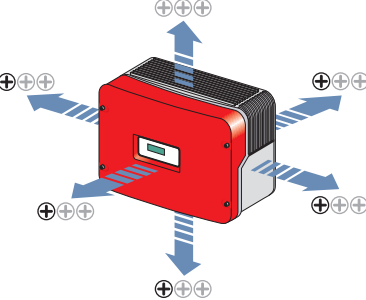
<b>Tested devices</b> (SB = Sunny Boy, SMC = Sunny Mini Central)	<b>Transmission power, depending                      on the enclosure side</b>	<b>Untested devices with                      comparable transmission power</b>  (SB = Sunny Boy, SMC = Sunny Mini Central, WB = Windy Boy)
<ul style="list-style-type: none"> <li>SB 1700 with SMA Bluetooth Piggy-Back</li> </ul>		<p><b>PV inverters:</b></p> <ul style="list-style-type: none"> <li>with SMA Bluetooth Piggy-Back:                             <ul style="list-style-type: none"> <li>SB 1100, SB 1100E, SB 1100LV, SB 1100-IT, SB 1200, SB 1200-IT, SB 1600TL-10, SB 1700, SB 1700E, SB 1700-IT, SB 2100TL, SB 2500, SB 2500-IT, SB 2500-KR, SB 2800i, SB 3000, SB 3000-IT, SB 3000-KR</li> </ul> </li> </ul> <p><b>Wind power inverters:</b></p> <ul style="list-style-type: none"> <li>with SMA Bluetooth Piggy-Back:                             <ul style="list-style-type: none"> <li>WB 1100, WB 1100-IT, WB 1100E, WB 1100LV, WB 1100LV-IT, WB 1200, WB 1200-IT, WB 1700, WB 1700E, WB 1700-IT, WB 2500, WB 2500-IT, WB 2800i, WB 3000, WB 3000-IT</li> </ul> </li> </ul>
<ul style="list-style-type: none"> <li>SB 3800 with SMA Bluetooth Piggy-Back</li> </ul>		<p><b>PV inverters:</b></p> <ul style="list-style-type: none"> <li>with SMA Bluetooth Piggy-Back:                             <ul style="list-style-type: none"> <li>SB 3300, SB 3300-IT, SB 3800, SB 3800-IT</li> </ul> </li> </ul> <p><b>Wind power inverters:</b></p> <ul style="list-style-type: none"> <li>with SMA Bluetooth Piggy-Back:                             <ul style="list-style-type: none"> <li>WB 3300, WB 3300-IT, WB 3800, WB 3800-IT</li> </ul> </li> </ul>

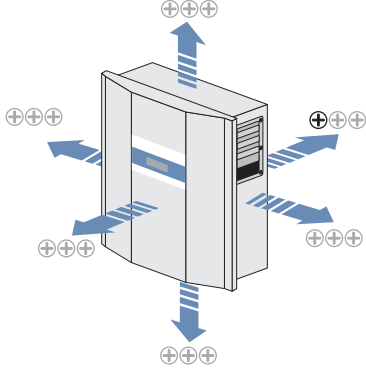
<b>Tested devices</b> (SB = Sunny Boy, SMC = Sunny Mini Central)	<b>Transmission power, depending                      on the enclosure side</b>	<b>Untested devices with                      comparable transmission power</b>  (SB = Sunny Boy, SMC = Sunny Mini Central, WB = Windy Boy)
<ul style="list-style-type: none"> <li>• SMC 5000 with                              SMA Bluetooth                              Piggy-Back</li> </ul>		<b>PV inverters:</b> <ul style="list-style-type: none"> <li>• with SMA Bluetooth Piggy-Back:                             <ul style="list-style-type: none"> <li>- SB 4200TL HC,</li> <li>SB 4200TL HC-IT,</li> <li>SB 5000TL HC,</li> <li>SB 5000TL HC-IT</li> </ul> </li> </ul>

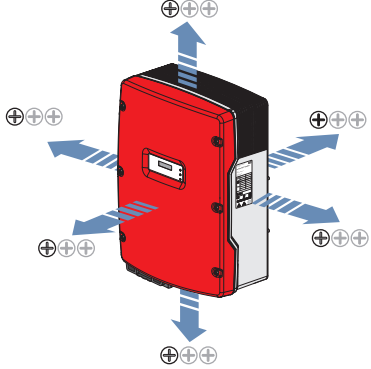
<b>Tested devices</b> (SB = Sunny Boy, SMC = Sunny Mini Central)	<b>Transmission power, depending                      on the enclosure side</b>	<b>Untested devices with                      comparable transmission power</b>  (SB = Sunny Boy, SMC = Sunny Mini Central, WB = Windy Boy)
<ul style="list-style-type: none"> <li>• SMC 11000TL with SMA Bluetooth Piggy-Back</li> </ul>		<p><b>PV inverters:</b></p> <ul style="list-style-type: none"> <li>• with SMA Bluetooth Piggy-Back:                             <ul style="list-style-type: none"> <li>- SMC 4600A, SMC 5000, SMC 5000A, SMC 5000A-IT, SMC 6000, SMC 6000A, SMC 6000A-IT, SMC 6000A-KR, SMC 7000HV, SMC 7000HV-IT, SMC 7000HV-11, SMC 7000HV-11/IT, SMC 6000TL, SMC 6000TL-IT, SMC 7000TL, SMC 7000TL-IT, SMC 8000TL, SMC 8000TL-IT, SMC 8000TL-KR, SMC 9000TL-10, SMC 9000TL-10/IT, SMC 10000TL-10, SMC 10000TL-10/IT, SMC 11000TL-10, SMC 11000TL-10/IT, SMC 9000TLRP-10, SMC 10000TLRP-10, SMC 11000TLRP-10</li> </ul> </li> </ul> <p><b>Wind power inverters:</b></p> <ul style="list-style-type: none"> <li>• with SMA Bluetooth Piggy-Back:                             <ul style="list-style-type: none"> <li>- WB 5000A, WB 5000A-IT, WB 6000A, WB 6000A-IT</li> </ul> </li> </ul>

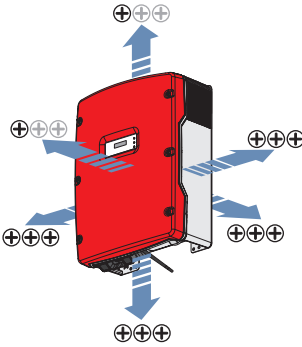

**Inverters with SMA Bluetooth Piggy-Back Plus**

<p><b>Tested devices</b> (SB = Sunny Boy, SMC = Sunny Mini Central)</p>	<p><b>Transmission power, depending on the enclosure side</b></p>	<p><b>Untested devices with comparable transmission power</b>  (SB = Sunny Boy, SMC = Sunny Mini Central, WB = Windy Boy)</p>
<ul style="list-style-type: none"> <li>SMC 6000TL with SMA Bluetooth Piggy-Back Plus</li> </ul>		<p><b>PV inverters:</b></p> <ul style="list-style-type: none"> <li>with SMA Bluetooth Piggy-Back Plus:                     <ul style="list-style-type: none"> <li>SMC 4600A, SMC 5000, SMC 5000A, SMC 5000A-IT, SMC 6000, SMC 6000A, SMC 6000A-IT, SMC 6000A-KR, SMC 7000HV, SMC 7000HV-IT, SMC 7000HV-11, SMC 7000HV-11/IT, SMC 6000TL, SMC 6000TL-IT, SMC 7000TL, SMC 7000TL-IT, SMC 8000TL, SMC 8000TL-IT, SMC 8000TL-KR, SMC 9000TL-10, SMC 9000TL-10/IT, SMC 10000TL-10, SMC 10000TL-10/IT, SMC 11000TL-10, SMC 11000TL-10/IT, SMC 9000TLRP-10, SMC 10000TLRP-10, SMC 11000TLRP-10</li> </ul> </li> </ul> <p><b>Wind power inverters:</b></p> <ul style="list-style-type: none"> <li>with SMA Bluetooth Piggy-Back Plus:                     <ul style="list-style-type: none"> <li>WB 5000A, WB 5000A-IT, WB 6000A, WB 6000A-IT</li> </ul> </li> </ul>

Communication Devices

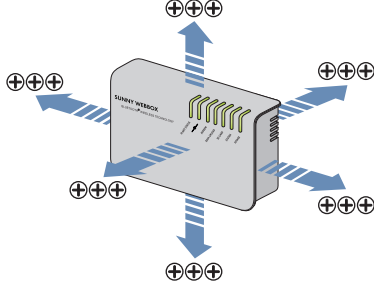
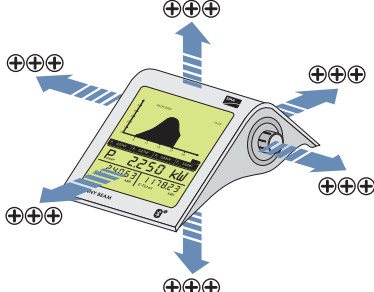
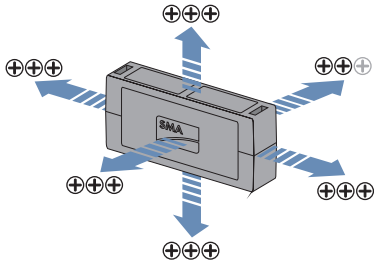
Tested device	Transmission power, depending on the enclosure side
<ul style="list-style-type: none"> <li>Sunny WebBox with <i>Bluetooth</i></li> </ul>	 <p>The diagram shows a Sunny WebBox device with six blue arrows pointing outwards in all directions. Each arrow is accompanied by a circle containing three plus signs (+++), indicating a transmission power level of 3 dBm.</p>
<ul style="list-style-type: none"> <li>Sunny Beam with <i>Bluetooth</i></li> </ul>	 <p>The diagram shows a Sunny Beam device with a display screen. Six blue arrows point outwards from the device, each accompanied by a circle containing three plus signs (+++), indicating a transmission power level of 3 dBm.</p>
<ul style="list-style-type: none"> <li>SMA <i>Bluetooth</i> Repeater</li> </ul>	 <p>The diagram shows an SMA Bluetooth Repeater device with six blue arrows pointing outwards in all directions. Each arrow is accompanied by a circle containing three plus signs (+++), indicating a transmission power level of 3 dBm.</p>

## 2.2 Number of Nodes

Up to 50 devices with the same NetID can participate in an SMA Bluetooth network\*. These devices include inverters and SMA Bluetooth Repeaters. In case you want to link more than 50 devices, you have to divide your PV plant into several Bluetooth networks by assigning different NetIDs. If your Bluetooth PV plant consists of 90 devices, for example, you can assign the NetID 3 for 45 devices and the NetID 4 for the remaining 45 devices. In this case, divide the PV plant into Bluetooth networks with an approximately equal number of devices (example: PV plant with 90 devices should not be divided into 60 and 30 devices, but into 45 and 45 devices). The fewer devices there are within a NetID, the faster the network structure and the data transmission are.

\*When the Sunny Explorer is used, the number of nodes depends on the number of masters; see Section "Sunny Explorer and Number of Slaves" (page 12).

## 2.3 Masters and Slaves

Masters and slaves are terms used in network engineering. In a network, a master is a device that, for example, requests other devices (slaves) to receive or send data. In a Bluetooth network from SMA Solar Technology AG, the following products are masters and slaves:

Role	Products	Properties
Master	<ul style="list-style-type: none"> <li>• Communication products, e.g.:                             <ul style="list-style-type: none"> <li>- Sunny WebBox with Bluetooth*</li> <li>- Sunny Beam with Bluetooth</li> <li>- Sunny Explorer (software for computer)</li> </ul> </li> </ul>	<ul style="list-style-type: none"> <li>• Initiates the setup of the Bluetooth network</li> <li>• Requests data</li> <li>• Sends data to slaves</li> </ul>
Slave	<ul style="list-style-type: none"> <li>• Inverter</li> <li>• SMA Bluetooth Repeater</li> </ul>	<ul style="list-style-type: none"> <li>• Implements the requests and inputs of the master</li> </ul>

\*The Sunny WebBox with Bluetooth is both master as well as slave (see Section "Special Feature of the Sunny WebBox with Bluetooth" (page 12)).

## 2.4 Number of Masters in the *Bluetooth* Network

A maximum of four masters can participate in a *Bluetooth* network at the same time. However, the number of masters depends on the number of slaves. The root node (A) is the slave via which the master directly connects to the *Bluetooth* network and initiates the setup of the complete *Bluetooth* network. Two masters can connect to this slave. Further inverters can only accept the connection of one master each. In order to participate simultaneously with the maximum number of four masters in a *Bluetooth* network, at least three slaves are required.

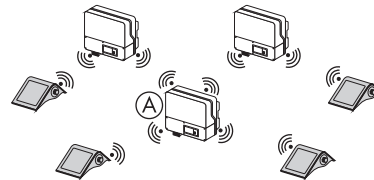

Number of slaves (Inverter or SMA <i>Bluetooth</i> Repeater)	Possible number of masters (e.g. Sunny Beam with <i>Bluetooth</i> , Sunny Explorer)
1	2
2	3
3	4
>3	4*

\*For PV plants with Sunny Explorer, read and observe the following section.

### Sunny Explorer and Number of Slaves

With Sunny Explorer you can manage up to 50 devices (slaves). If you want to use other communication products besides Sunny Explorer, your PV plant should comprise fewer slaves. The following table lists the number of possible slaves:

Number of masters	Possible number of slaves
1 Sunny Explorer	up to 50
1 Sunny Explorer and 1 other communication product	up to 25
1 Sunny Explorer and 2 other communication products	up to 12
1 Sunny Explorer and 3 other communication products	3 to 6

### Special Feature of the Sunny WebBox with *Bluetooth*

The Sunny WebBox with *Bluetooth* operates as both master and slave in the *Bluetooth* network and has, in addition to the characteristics of a master, the following characteristics:

- Operates as a repeater and is able to close dead zones within the *Bluetooth* network
- Serves as a root node and thus enables masters to connect to the *Bluetooth* network
- Sends data to slaves and masters

### 3 Feed-In and Grid Management

Feeding-in and grid management means that in the event of a grid overload, the network operator can remotely limit the feed-in power of the PV plant. The PV plant must be equipped with a system that allows the network operator to limit the power for safety reasons. Information on regulations for feeding-in and grid management in your country can be obtained from your network operator. For PV plants with planned grid management, SMA Solar Technology AG recommends wired communication. Using wired communication ensures that the network operator has access to the PV plant at all times.

The following figure shows the solution from SMA Solar Technology AG for PV plants that must contribute to feed-in management. The Power Reducer Box allows the network operator to implement active power limitation or the reactive power setpoint.

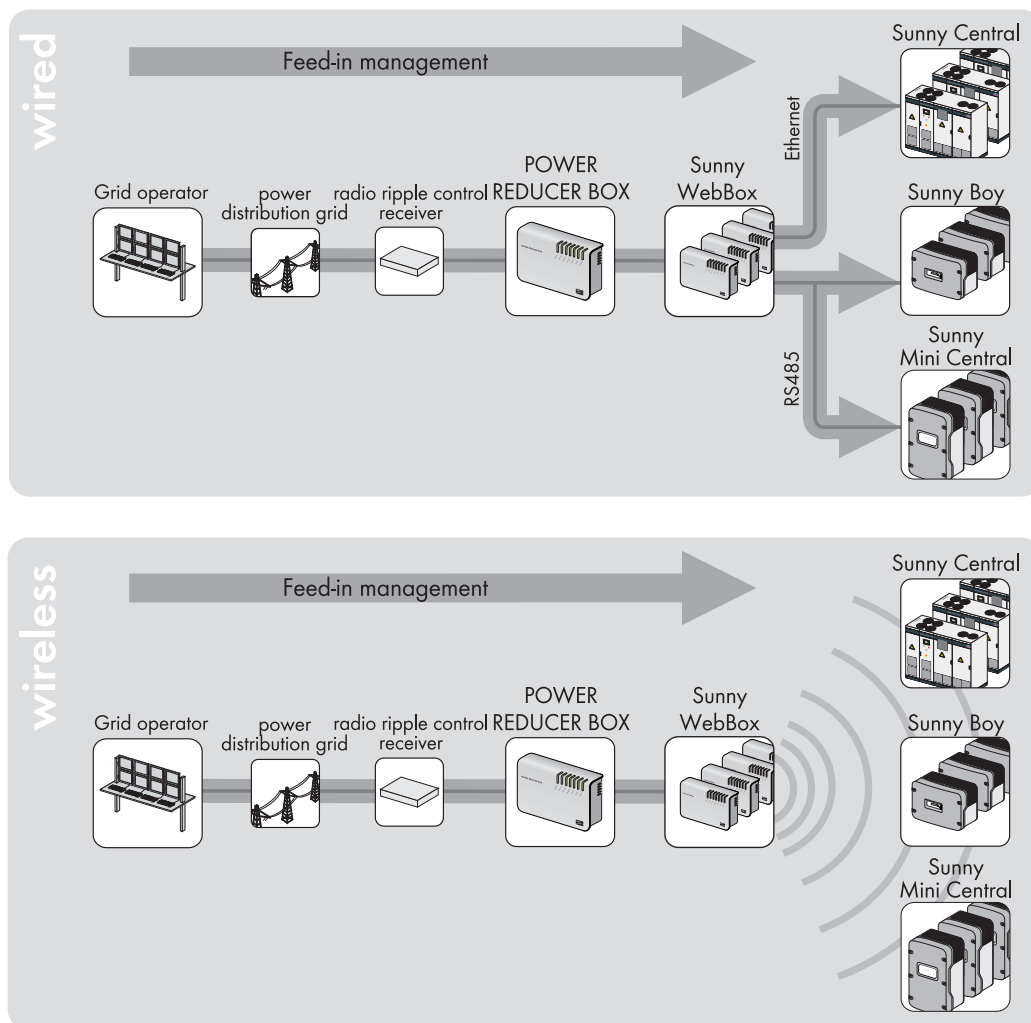

## 4 Safety of SMA Bluetooth

---

SMA Solar Technology AG offers inverters of different power classes with SMA Bluetooth. Measurement, event and meter information can be wirelessly retrieved from the inverters via SMA communication products. It is also possible to wirelessly change the parameters settings.

SMA Solar Technology AG provides a comprehensive security concept that protects the Bluetooth devices of your PV plant from unauthorised access.

- Plant password: securing all Bluetooth devices of your PV plant via a system password, transmitted encrypted, for each user group (user/installer)
- SMA Grid Guard: controlled access to safety-relevant parameters via SMA Grid Guard

### Plant Password

The inverters with integrated Bluetooth or an SMA Bluetooth Piggy-Back are delivered ex works with preset plant passwords. These are the same for all SMA Bluetooth Piggy-Backs and all inverters with Bluetooth. To protect the PV plant from unauthorised access, you should change the default plant passwords for the user groups "Installer" and "User" or set the NetID of all inverters to 0 (Bluetooth switched off) when no wireless plant communication is to be used. However, SMA Solar Technology AG recommends changing the plant passwords since the preset NetID 1 and higher facilitates access for a service technician. You can change the plant passwords by using a computer with Bluetooth and the Sunny Explorer software or by means of a Sunny WebBox with Bluetooth. How to change the plant passwords is described in the user manual of the Sunny Explorer and/or the user manual of the Sunny WebBox with Bluetooth.

You can obtain the Sunny Explorer for free in the download Section of [www.SMA.de/en](http://www.SMA.de/en). Inform the user of the changed user password.

### SMA Grid Guard

SMA Grid Guard is a safety concept for country-specific settings in the inverter, determining the grid behaviour within an electricity grid. These settings (SMA Grid Guard parameters) are pre-installed in the devices and can only be configured with the SMA Grid Guard password.

In order to change SMA Grid Guard parameters, you must be logged in as an installer and you will also need your personal SMA Grid Guard password, which you can obtain from SMA Solar Technology AG. Contact the SMA Service Line.

## 5 Storage Capacity of the Inverters

---

### **Inverters with Integrated SMA Bluetooth**

Inverters with integrated SMA *Bluetooth* have the following storage capacity:

- Total yield "E-total" in five minute averages for 63 days
- Daily yield "E-day" as end-of-day values for 30 years
- 250 "Events" for the user group "User"
- 250 "Events" for the user group "Installer"

### **Inverters with Retrofitted SMA Bluetooth (SMA Bluetooth Piggy-Back and SMA Bluetooth Piggy-Back Plus)**

The value "E-day" can be saved by inverters with retrofitted SMA *Bluetooth* from SMA *Bluetooth* Piggy-Back firmware version 2.00.01.R and from SMA *Bluetooth* Piggy-Back Plus firmware version 2.00.03.R. Otherwise, these inverters have the same storage capacity as inverters with an integrated SMA *Bluetooth*. However, the SMA *Bluetooth* Piggy-Back and the SMA *Bluetooth* Piggy-Back Plus can save the data only if a master is connected to the PV plant at least once a day thus transmitting the time. The reason is that otherwise the SMA *Bluetooth* Piggy-Back and the SMA *Bluetooth* Piggy-Back Plus cannot assign the data any time and date and therefore cannot save it. Note that the master can connect to the inverter and an SMA *Bluetooth* Piggy-Back or an SMA *Bluetooth* Piggy-Back Plus only when the inverter is in feed-in operation.