

Installation Requirements

for the Italian station concept

for **SUNNY CENTRAL 400MV/500MV/630MV/800MV/1000MV/1250MV**



Contents

This document describes the dimensions, the minimum clearances and cable routing, and the transport requirements which must be observed to ensure smooth installation. This document is valid for the following Sunny Central models:

- Sunny Central 400MV-IT
- Sunny Central 500MV-IT
- Sunny Central 630MV-IT
- Sunny Central 800MV-IT
- Sunny Central 1000MV-IT
- Sunny Central 1250MV-IT

1 Mechanical Data

Sunny Central 800MV/1000MV/1250MV with medium-voltage switchgear

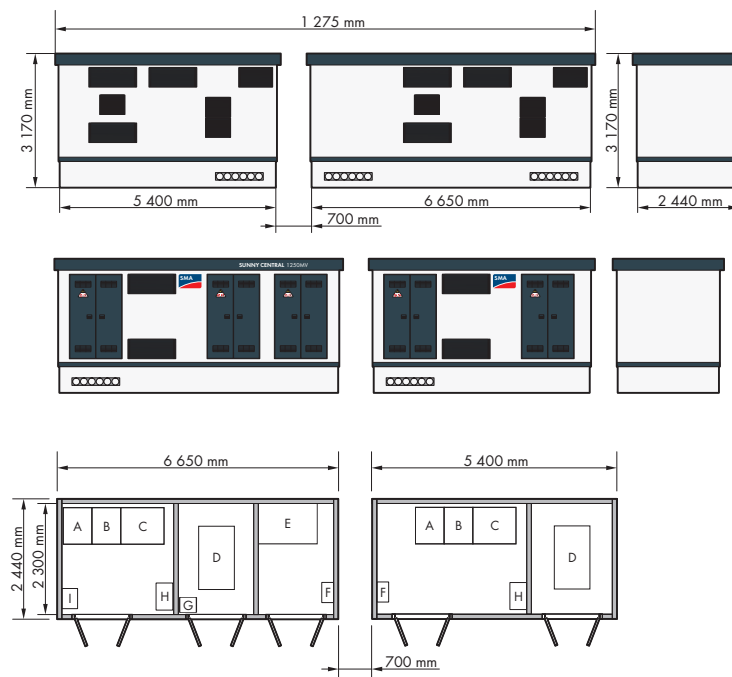

- | | | | |
|---|---|---|---------------------------------|
| A | Sunny Central, DC cabinet | B | Sunny Central, inverter cabinet |
| C | Sunny Central, AC cabinet | D | Transformer |
| E | Medium-voltage switchgear | F | Station sub-distribution |
| G | Transformer for internal power supply, optional | H | GSE meter, optional |
| I | COM-B, optional | | |

Sunny Central 800MV/1000MV/1250MV without medium-voltage switchgear

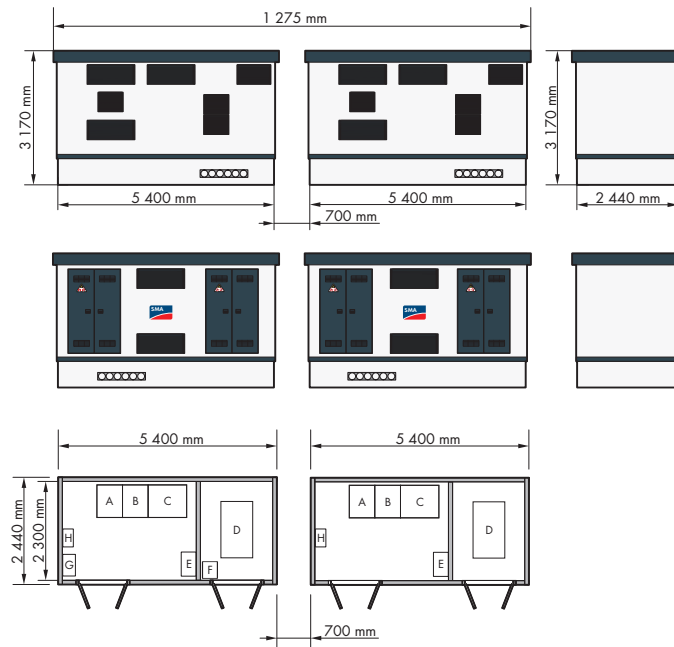

- | | | | |
|---|---------------------------|---|---|
| A | Sunny Central, DC cabinet | B | Sunny Central, inverter cabinet |
| C | Sunny Central, AC cabinet | D | Transformer |
| E | GSE meter, optional | F | Transformer for internal power supply, optional |
| G | COM-B, optional | H | Station sub-distribution |

Sunny Central 400MV/500MV/630MV with medium-voltage switchgear

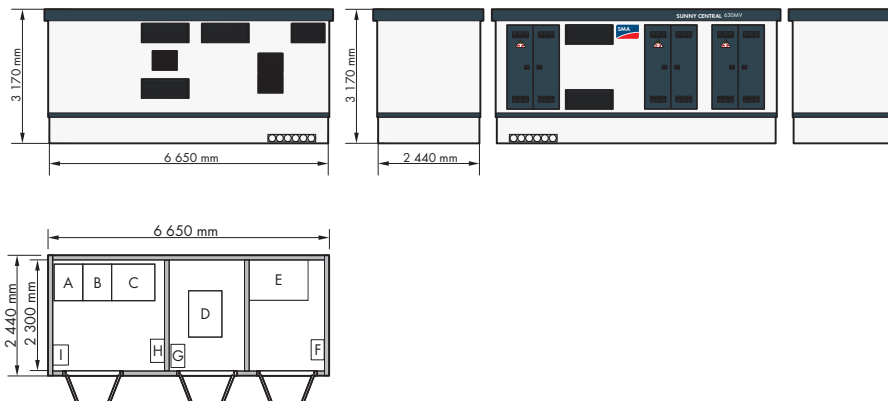

- | | | | |
|---|---|---|---------------------------------|
| A | Sunny Central, DC cabinet | B | Sunny Central, inverter cabinet |
| C | Sunny Central, AC cabinet | D | Transformer |
| E | Medium-voltage switchgear | F | Station sub-distribution |
| G | Transformer for internal power supply, optional | H | GSE meter, optional |
| I | COM-B, optional | | |

Sunny Central 400MV/500MV/630MV without medium-voltage switchgear

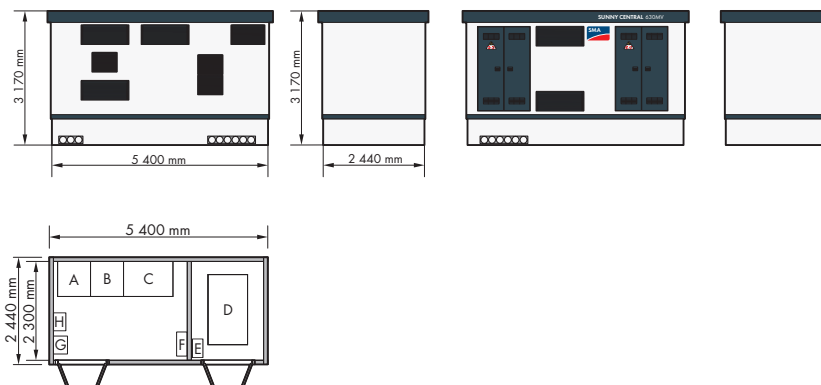

- | | | | |
|---|---|---|---------------------------------|
| A | Sunny Central, DC cabinet | B | Sunny Central, inverter cabinet |
| C | Sunny Central, AC cabinet | D | Transformer |
| E | Transformer for internal power supply, optional | F | GSE meter, optional |
| G | COM-B, optional | H | Station sub-distribution |

2 Transport Requirements

2.1 Freight-Forwarding Company

Transporting and unloading is coordinated by a freight-forwarding company. Normally, the freight-forwarding company will arrange a day for delivering and unloading with the site management three weeks prior to the planned delivery date.

2.2 Delivery

Delivery with separate crane

This type of delivery is recommended by SMA Solar Technology AG.

For this, the following conditions must be fulfilled:

Driveway:	Surface at the installation site:
<ul style="list-style-type: none"> • Firm • Gradient: max. 4 % • Width: min. 3.5 m • Suitable for a truck with the following properties: <ul style="list-style-type: none"> - Weight: max. 50 t - Length: at max. 16.5 m - Width: max. 2.5 m - Height: at maximum 5 m - Ground clearance: at least 0.25 m 	<ul style="list-style-type: none"> • Dry • Compacted • Level • Firm

The following figure shows the location requirements for delivery with a separate crane.

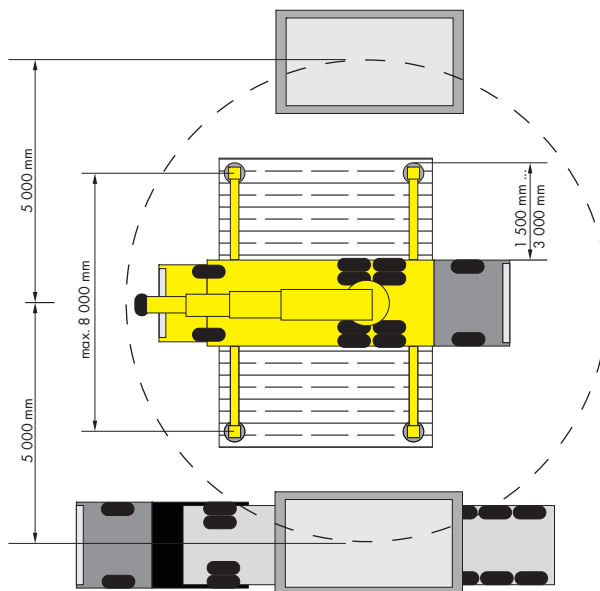

Delivery by truck with assembly crane

Alternatively to delivery with a separate crane, the system can also be delivered by a truck fitted with an assembly crane if there is insufficient space.

For this, the following conditions must be fulfilled:

Driveway:	Surface at the installation site:
<ul style="list-style-type: none"> • Firm • Gradient: max. 4 % • Width: min. 3.5 m • Suitable for a truck with the following properties: <ul style="list-style-type: none"> - Weight: max. 50 t - Length: max. 9 m - Width: max. 2.5 m - Ground clearance: at least 0.25 m 	<ul style="list-style-type: none"> • Dry • Compacted • Level • Firm

The following figure shows the location requirements for delivery by a truck fitted with an assembly crane.

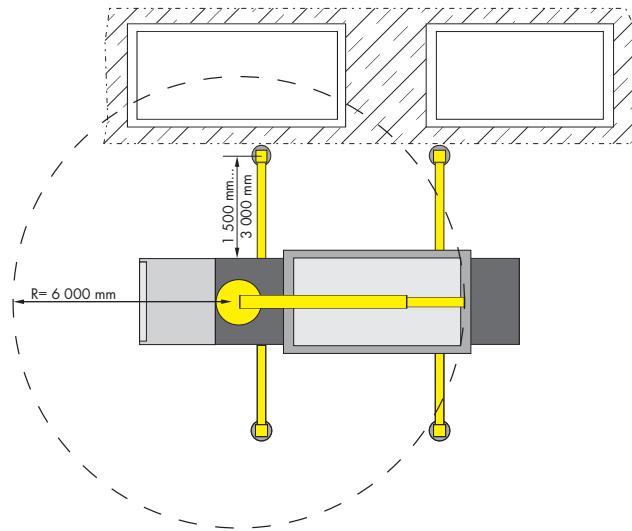

Prior to delivery, remove all obstacles such as fences, power lines, trees (or similar) that could obstruct access by truck.

If the ambient conditions cannot be fulfilled, it may be necessary to use a larger crane. The final crane size will be determined on a site visit.

Delivery and transport are included in the scope of service. Additional delivery costs may be incurred in the following cases:

- traffic-control measures such as road blocks, police escorts, etc. become necessary
- a separate crane with a larger range is required.
- an additional traction engine is required for steep inclines.
- excavator mats, etc. are needed.

2.3 Foundation

The excavation pit and foundation are to be prepared on site in accordance with the foundation drawing. Ensure that the following requirements are met:

Foundation:	Subgrade:
<ul style="list-style-type: none"> Excavation depth of station: max. 0.5 m Exterior grounding systems are to be executed according to the instructions of the electric utility company or distribution grid operator. The work area must be minimum 0.5 m in wall areas with cable routing. The corners of the excavation pit must be marked. The excavated material is dumped in a location which cannot hinder the truck during transport. 	<ul style="list-style-type: none"> Height: approx. 100 mm Relative compaction: 98 % Soil pressure: 150 kN/m² Drawn off level

The dimensions of the foundation can be found in the following diagrams.

Sunny Central 800MV/1000MV/1250MV without medium-voltage switchgear

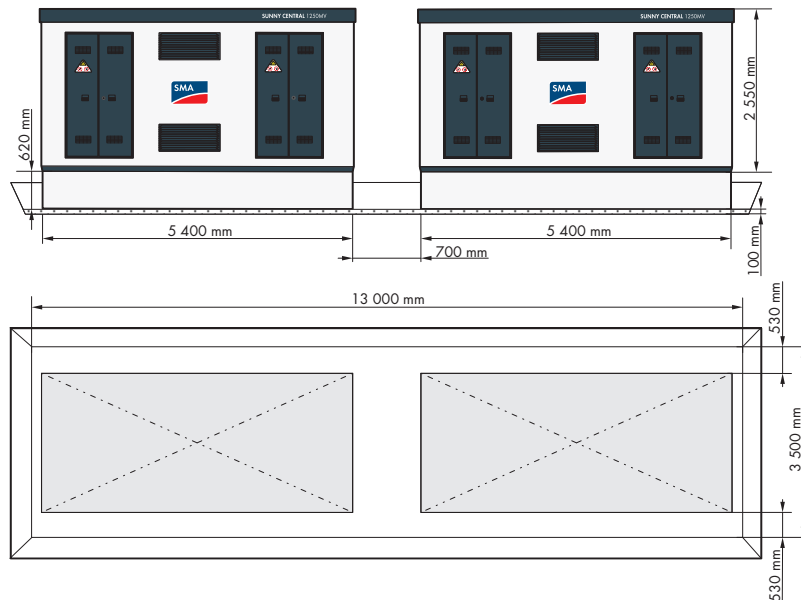

Sunny Central 800MV/1000MV/1250MV with medium-voltage switchgear

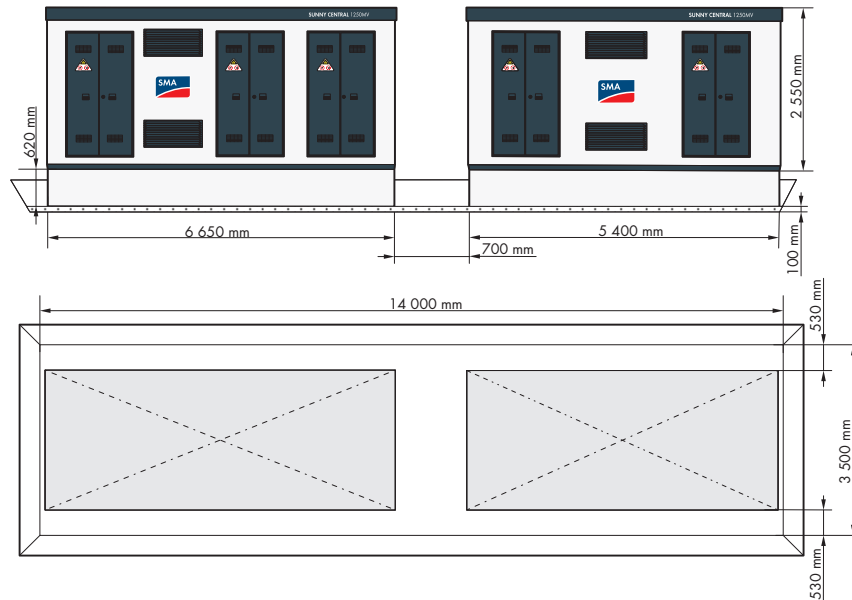

Sunny Central 400MV/500MV/630MV without medium-voltage switchgear

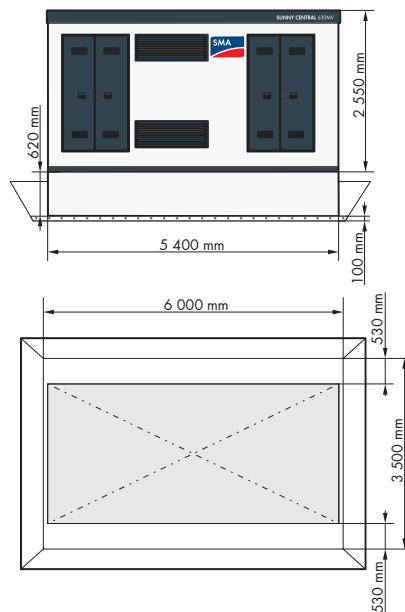

Sunny Central 400MV/500MV/630MV with medium-voltage switchgear

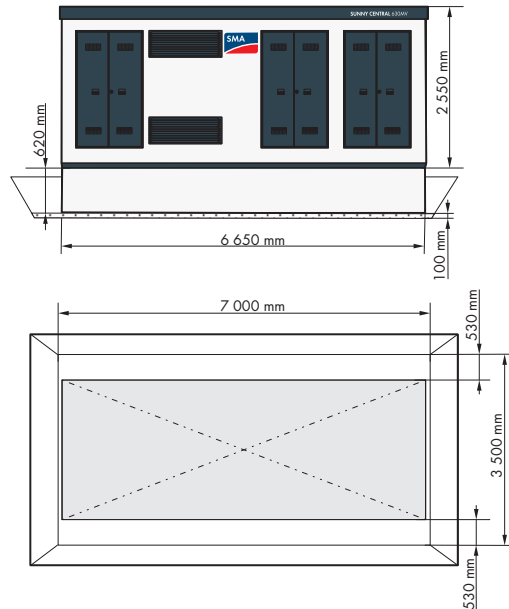

2.4 Minimum Clearances

Keep a minimum clearance of at least 1 800 mm in front of the doors of the MV Station. Keep a clearance of at least 1 000 mm at the sides without doors.

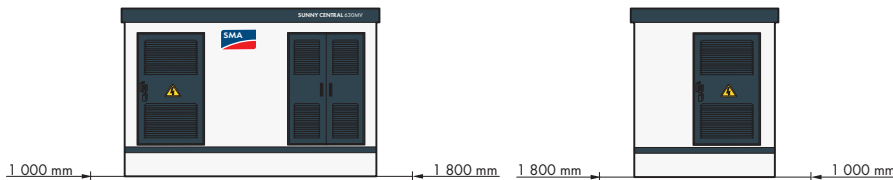

Ensure a safety clearance of 5 000 mm to objects which are inflammable or could potentially cause fires. In order to disconnect the MV station in case of failures, observe a safety clearance of 10 000 mm between the MV station and the DC sub distributions.

2.5 Drainage

A drainage system must be provided on site to protect the MV station from water penetration.

3 Electrical Connection

3.1 Block circuit diagram

Sunny Central 800MV/1000MV/1250MV with medium-voltage switchgear for ring switching

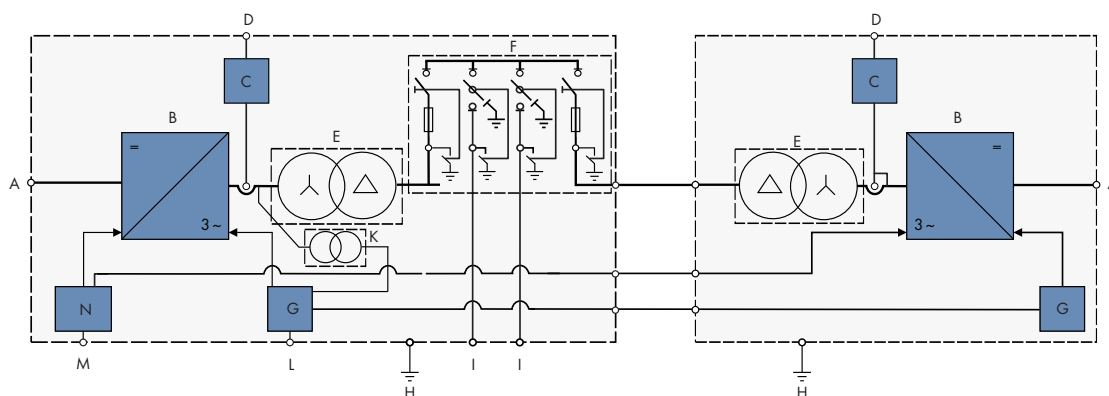

- | | | | |
|---|--------------------------|---|---|
| A | DC Input | B | Sunny Central |
| C | GSE meter, optional | D | RS485 communication interface |
| E | Transformer Dy11 | F | Medium-voltage switchgear TM-I-I-TM |
| G | Station sub-distribution | H | External grounding |
| I | AC Output | K | Transformer for internal power supply, optional |
| L | External voltage supply | M | Communication interface |
| N | COM-B, optional | | |

3.2 Cable Entry

Cable entries

The cable conduits of the stations have been prepared for HRD 200 Hauff system lids. Corresponding inserts are not included in delivery.

Sunny Central 800MV/1000MV/1250MV

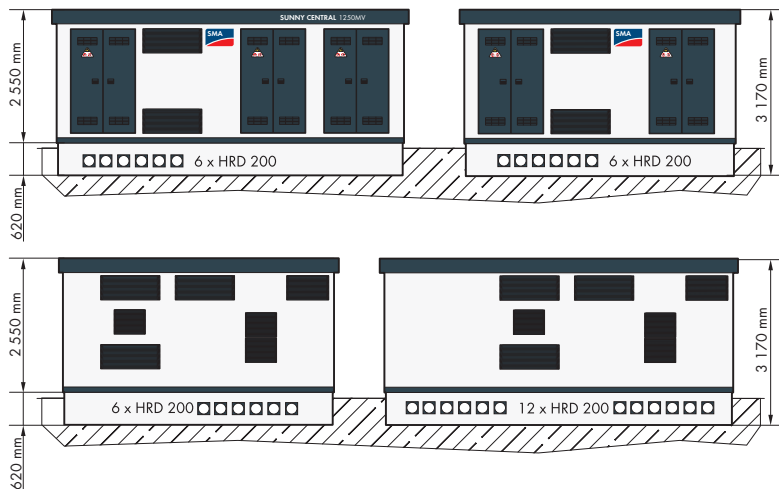

Sunny Central 400MV/500MV/630MV

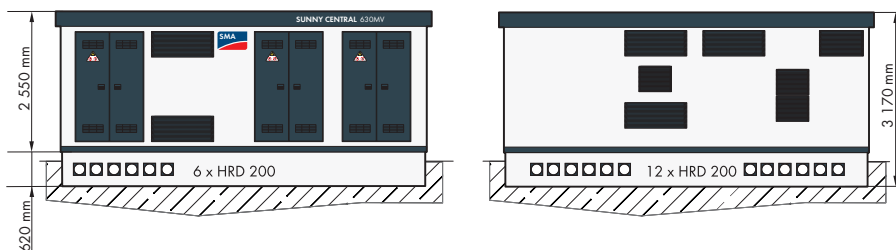

3.3 Cable cross-sections

The AC connection is to be executed in compliance with the installation guide for the MV switchgear and/or the transformer.

3.4 Equipotential Bonding

The MV station must be included in equipotential bonding.

4 Color

RAL 7024	Graphite gray/aluminum	Doors, ventilation grids
RAL 7024	Graphite gray	Roof covers, plinths
RAL 7035	Light gray	Exterior walls
RAL 9010	Pure white	Interior walls