



PV inverter

# **SUNNY MINI CENTRAL 4600A/5000A/6000A**

**User Manual**





# Table of Contents

<b>1</b>	<b>Information on this Manual</b> . . . . .	<b>5</b>
1.1	Validity . . . . .	5
1.2	Target group . . . . .	5
1.3	Additional Information . . . . .	5
1.4	Symbols Used . . . . .	6
<b>2</b>	<b>Safety</b> . . . . .	<b>7</b>
2.1	Intended Use . . . . .	7
2.2	Safety Instructions . . . . .	8
2.3	Explanation of Symbols . . . . .	9
2.3.1	Symbols on the Inverter . . . . .	9
2.3.2	Symbols on the Type Label . . . . .	10
<b>3</b>	<b>Product Overview</b> . . . . .	<b>11</b>
<b>4</b>	<b>Display</b> . . . . .	<b>12</b>
4.1	Operation . . . . .	12
4.2	Display Messages during Operation . . . . .	12
4.3	Display Messages during a Disturbance . . . . .	13
4.4	DC overvoltage . . . . .	13
<b>5</b>	<b>LED signals</b> . . . . .	<b>14</b>
<b>6</b>	<b>Visual Inspection, Maintenance and Cleaning</b> . . . . .	<b>16</b>
<b>7</b>	<b>Troubleshooting</b> . . . . .	<b>17</b>
7.1	Status Messages . . . . .	17
7.2	Measurement Channels . . . . .	18
<b>8</b>	<b>Glossary</b> . . . . .	<b>19</b>
<b>9</b>	<b>Contact</b> . . . . .	<b>20</b>



# 1 Information on this Manual

## 1.1 Validity

This manual covers the following devices:

- SMC 4600A
- SMC 5000A
- SMC 6000A
- SMC 4600A-11
- SMC 5000A-11
- SMC 6000A-11
- SMC 5000A-IT
- SMC 6000A-IT

## 1.2 Target group

This manual is for the operator.





## 1.3 Additional Information

You will find additional information on the device-specific technical data in the installation manual provided.

You will find additional information on special subjects (e.g. description of the operating parameters) in the download area at [www.SMA.de/en](http://www.SMA.de/en).

## 1.4 Symbols Used

The following types of safety instructions and general information are used in this manual:

	<b>DANGER!</b>
DANGER indicates a hazardous situation which, if not avoided, will result in death or serious injury.	
	<b>WARNING!</b>
WARNING indicates a hazardous situation which, if not avoided, could result in death or serious injury.	
	<b>CAUTION!</b>
CAUTION indicates a hazardous situation which, if not avoided, could result in minor or moderate injury.	
	<b>NOTICE!</b>
NOTICE indicates a situation that can result in property damage if not avoided.	
	<b>Information</b>
Information provides tips that are valuable for the optimal installation and operation of the product.	

## 2 Safety

### 2.1 Intended Use

The Sunny Mini Central is a PV inverter, which converts the direct current of the PV array to grid-compliant alternating current and feeds it into the power distribution grid.

#### Operating Principle of a PV Plant with Sunny Mini Central

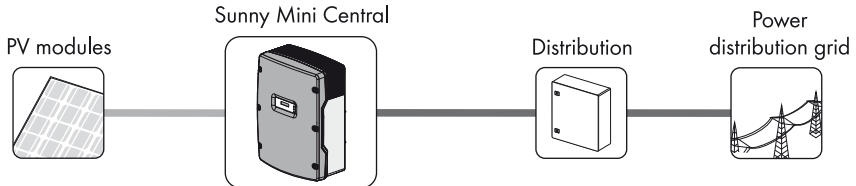

The Sunny Mini Central is suitable for indoor and outdoor use.

The Sunny Mini Central may only be operated with PV arrays (PV modules and cabling) of protection class II. Do not connect any energy sources other than PV modules to the Sunny Mini Central.

Do not use the Sunny Mini Central for purposes other than those described here. Alternative uses, modifications to the Sunny Mini Central or the installation of components not expressly recommended or sold by SMA Solar Technology AG void the warranty claims and operation permission. Contact the SMA Service Line if you need clarification regarding the intended use of the inverter.

This manual is a part of the Sunny Mini Central. Observe all of the activities described in this document. Keep this manual in a convenient place for future reference.

## 2.2 Safety Instructions

**DANGER!**

**Electric shock caused by high voltage in the inverter.**

Even when no external voltage is present, there can still be high voltages in the inverter. The following work should only be carried out by a trained electrically skilled person:

- Electrical installation
- Repair
- Modification

**CAUTION!**

**Risk of burns through contact with the enclosure during operation.**

- Only touch the enclosure lid and display during operation.

**NOTICE!**

**Damage to the inverter through overvoltage, if the yellow LED flashes 4 times.**





- Inform your installer immediately if the yellow LED should start flashing and the following display message appears.

```
!PU-Overvoltage!  
!DISCONNECT DC!
```



## 2.3 Explanation of Symbols











### 2.3.1 Symbols on the Inverter

Symbol	Explanation
	Operation display.
	Ground fault or varistor defective. Inform your installer.
	An error has occurred. Inform your installer <b>immediately</b> .
	<p>You can operate the display by tapping the enclosure lid.</p> <ul style="list-style-type: none"> <li>• Tapping once: The background light switches on or the display scrolls one message further.</li> <li>• 2 taps in quick succession*: The inverter shows the device type, the firmware version and the configured standard (see section 4.2 "Display Messages during Operation" (page 12)).</li> </ul>
	<p>QR-Code®** for SMA bonus program</p> <p>You will find information on the SMA bonus program at <a href="http://www.SMA-Bonus.com">www.SMA-Bonus.com</a>.</p>

\* This function is valid from firmware version 2.15.

\*\* QR-Code is a registered trademark of DENSO WAVE INCORPORATED.

### 2.3.2 Symbols on the Type Label

Symbol	Explanation
	Beware of hazardous voltage. The inverter operates at high voltages. All work on the inverter may only be carried out by an electrically qualified person.
	Beware of hot surface. The inverter can become hot during operation. Avoid contact during operation.
	Observe all documentation that accompanies the inverter.
	The inverter must not be disposed of together with the household waste. Further disposal information can be found in the enclosed installation manual.
	CE mark. The inverter complies with the requirements of the applicable EC guidelines.
	The inverter has a transformer.
	Direct current (DC).
	Alternating current (AC).
	Degree of protection IP65 The inverter is protected against dust intrusion and water jets from any angle.
	RAL quality mark for solar products The inverter complies with the requirements of the German Institute for Quality Assurance and Labeling.

### 3 Product Overview

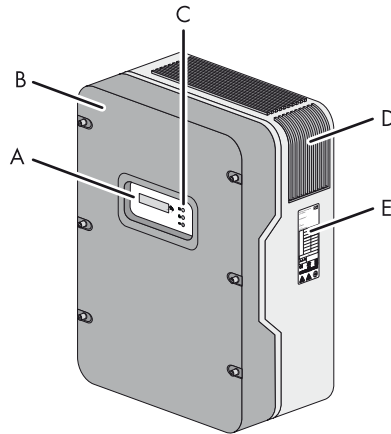

Position	Designation
A	Display
B	Enclosure lid
C	LEDs Green LED = Operation Red LED = Ground fault or varistor defective Yellow LED = Fault
D	Ventilation grid
E	Type label for the identification of the inverter via the serial number (Serial No.)

## 4 Display

### 4.1 Operation

The display shows the current values of your plant. The displayed values are updated every 5 seconds.

You can operate the display by tapping the enclosure lid.

#### Single tap:

The background illumination switches on or the display scrolls one message further.

#### 2 taps in quick succession (valid from firmware version 2.15):

The inverter displays the device type, the firmware version, the configured country setting one after the other, and the configuration of the SMA Power Balancer.

### 4.2 Display Messages during Operation

After commissioning, the inverter displays the device type, the firmware version, the configured country standard one after the other, and the configuration of the SMA Power Balancer. If you want to view the display messages of the startup phase again while in normal operation, double tap the enclosure lid (from firmware version 2.15).

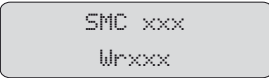
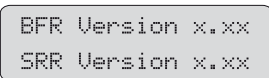
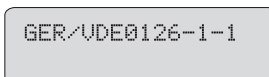
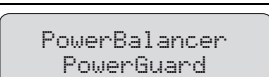
Display message	Description
	Inverter device type
	Firmware version of internal processors
	Configured country standard of inverter (example: "GER/VDE0126-1-1")
	Configuration of the SMA Power Balancer (Example: "PowerGuard")

Upon error-free connection of the inverter to the power distribution grid, after approximately 1 minute, the display starts alternating between the messages shown below. Each message appears for 5 seconds, and then the cycle restarts from the beginning.

Display message	Description
<pre> E-today    0Wh Mode       MPP           </pre>	Energy generated on the current day Status message "MPP"
<pre> Pac        903W Upv        360V           </pre>	Current feed-in power Voltage of the PV array
<pre> Qac        200VAR PF         0.987           </pre>	After a further 5 seconds or after tapping the actual values of the reactive power Qac and of the displacement power factor $\cos \varphi$ (PF) are displayed.
<pre> E-total    0Wh h-total    0h           </pre>	Total amount of energy fed in Total number of operating hours in feed-in operation

### 4.3 Display Messages during a Disturbance

In the event of a disturbance, the inverter displays the status "Disturbance" and an error message. Inform your installer.



Display message	Description
<pre> E-today    0Wh Mode       Disturbance           </pre>	Energy generated on the current day Status message "Disturbance"
<pre> Disturbance Uac-Bfr           </pre>	Operating state Error message
<pre> at:        261V present:   245V           </pre>	Measured value at the time of the disturbance Current measured value (only displayed if a measured value is responsible for the disturbance)

### 4.4 DC overvoltage

Display message	Description
<pre> !PU-Overvoltage! !DISCONNECT DC!           </pre>	The DC input voltage is too high at the inverter. Inform your installer <b>immediately!</b>

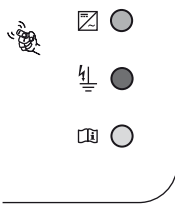
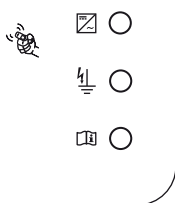
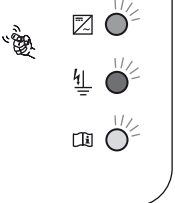
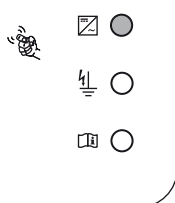
## 5 LED signals

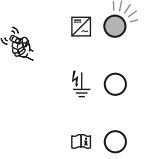
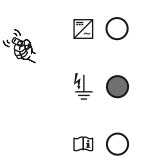
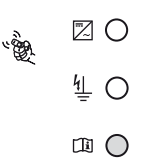
Status	Description	
	All LEDs are on	The inverter is initializing.
	All LEDs are off	The DC input voltage at the inverter is too low for feed-in.
	All LEDs flashing	The inverter is in the start phase.
	Green LED on	The inverter is feeding in to the power distribution grid.

Status	Description	
	Green LED flashing	<p>This blinking can be caused by:</p> <ul style="list-style-type: none"> <li>• The inverter is monitoring the power distribution grid and is waiting for the DC voltage to reach a defined limit so that it can begin feeding the grid.</li> <li>• Operation interrupted.</li> <li>• Power limitation in the inverter.</li> </ul>
	Red LED on	<p>A ground fault has occurred or one of the thermally monitored varistors on the DC input side is defective. Inform your installer.</p>
	Yellow LED on	<p>The inverter is in the operating state "Dauerhafte Betriebshemmung" (Permanent Shutdown). This can have several causes. Inform your installer.</p>
	Yellow LED flashing	<p>The inverter displays a disturbance. This can have several causes. Inform your installer.</p>

## 6 Visual Inspection, Maintenance and Cleaning

### Visual inspection

Check the inverter and cables for any visible signs of external damage. Contact your installer if you find any damage. Do not perform any repair work yourself.

### Maintenance and cleaning

Ask your installer to check for correct inverter operation at regular intervals.

If the inverter is dirty and the visibility of the operating data and operating states of the inverter is only limited, clean the enclosure lid, the display and the LEDs with a damp cloth. Do not use any corrosive substances (e.g. solvents, abrasives) for cleaning.



## 7 Troubleshooting

### 7.1 Status Messages

Your inverter can be in various operating states. These are displayed as status messages, which can vary according to the type of communication.

Message	Description
Balanced	The inverter has disconnected from the power distribution grid or is limiting its power over a 10 minute average to 4.6 kVA (in Italy: 6 kVA). The inverter is a part of a 3 phase system with 2 further inverters and equipped with the SMA Power Balancer for the avoidance of unbalanced loads.
Derating	Overtemperature in the inverter. The inverter reduces its output to prevent overheating. To avoid unnecessary yield penalties, the design of the PV plant should be checked. Inform your installer.
Error	An error has been detected. Inform your installer.
MPP	The inverter is operating in MPP mode. MPP is the standard display message when operating under normal radiation conditions.
MPP Peak	The inverter is operating in MPP mode above its nominal power.
Mpp-Search	The inverter is calculating the MPP.
grid mon.	Grid monitoring This display appears during the start phase, before the inverter is connected to the power distribution grid, predominantly in the morning and evening when radiation is too low and after an error.
Off Grid	The inverter is in "Island" mode. This mode is specially designed for operation in an off-grid system.
OFFSET	Offset adjustment of the measurement electronics.
Riso	Measurement of the insulation resistance of the PV plant.
Disturbance, disturbance	Disturbance. This message appears for safety reasons and ensures that the inverter does not connect to the power distribution grid. Inform your installer.
Stop	Operation interrupted.
V-Const	Constant voltage operation.
Waiting	The conditions for connecting are not (yet) fulfilled.

## 7.2 Measurement Channels

If your inverter is equipped with a communication product, then numerous measuring channels and messages can be transmitted for diagnostics.

Measurement channel	Description
Balancer	Displays the current operating mode of the inverter that is set to the operating parameter "PowerBalancer".
E-Total	Total amount of energy fed in
Event-Cnt	Number of events that have occurred
Fac	Power frequency
Error	Identification of the actual disturbance/error
h-On	Total operating hours
h-total	Total number of operating hours in feed-in operation
Iac	Grid current
Ipv	Direct current
Is*	Apparent current
Power On	Total number of grid connections
Pac	Generated AC power
Phase	The phase to which the inverter is connected.
PF*	Displacement power factor $\cos \varphi$
Qac	Reactive power
Riso	Insulation resistance of the PV plant before entering into the power distribution grid.
Sac*	Apparent power
Serial Number	inverter serial number
Status	Display of the current operating state
Vac	Grid voltage
Vpv	PV input voltage
Vpv-Setpoint	PV setpoint voltage

\* Included from firmware version 2.15

## 8 Glossary

### AC

Abbreviation for "alternating current."

### DC

Abbreviation for "direct current."

### Derating

A controlled reduction in performance, usually dependent on component temperatures.

### Electronic Solar Switch (ESS)

The Electronic Solar Switch is part of the inverter DC disconnection unit. The Electronic Solar Switch must be securely inserted into the bottom of the inverter and may only be removed by an electrically qualified person.

### MPP (Maximum Power Point)

Operating point of the inverter from current / voltage of the PV array. The actual position of the MPP changes constantly, depending on the level of radiation and cell temperature.

### PV

Abbreviation for photovoltaics.

### SMA Power Balancer

The SMA Power Balancer is a serial feature of the Sunny Mini Central. The SMA Power Balancer prevents the formation of an unbalanced load > 4.6 kVA (in Italy > 6 kVA) during three-phase grid feed-in. To this effect, 3 Sunny Mini Centrals are connected via a control line to a 3-phase feed-in unit.

### Unbalanced load

The unbalanced load is the difference between the power fed into the grid at the individual line conductors. In Germany, this must not exceed 4.6 kVA. In Italy, the unbalanced load is restricted to 6 kVA.

### Varistor

The varistors protect the electronics in the inverter from atmospherically coupled energy peaks, such as those that can occur when lightning strikes nearby.

## 9 Contact

If you have technical problems, first contact your installer. The following information is required in order to provide you with the necessary assistance:

- Inverter device type
- inverter serial number
- Type and number of connected PV modules
- Blink code or display message of the inverter
- Optional equipment (e.g. communication products)

### **SMA Solar Technology AG**

Sonnenallee 1

34266 Niestetal, Germany

[www.SMA.de](http://www.SMA.de)

### **SMA Service Line**

Inverters: +49 561 9522 1499

Communication: +49 561 9522 2499

Fax: +49 561 9522 4699

E-Mail: [ServiceLine@SMA.de](mailto:ServiceLine@SMA.de)





The information contained in this document is the property of SMA Solar Technology AG. Publishing its content, either partially or in full, requires the written permission of SMA Solar Technology AG. Any internal company copying of the document for the purposes of evaluating the product or its correct implementation is allowed and does not require permission.

## Exclusion of liability

The general terms and conditions of delivery of SMA Solar Technology AG shall apply.

The content of these documents is continually checked and amended, where necessary. However, discrepancies cannot be excluded. No guarantee is made for the completeness of these documents. The latest version is available online at [www.SMA.de](http://www.SMA.de) or from the usual sales channels.

Guarantee or liability claims for damages of any kind are excluded if they are caused by one or more of the following:

- Damages during transportation
- Improper or inappropriate use of the product
- Operating the product in an unintended environment
- Operating the product whilst ignoring relevant, statutory safety regulations in the deployment location
- Ignoring safety warnings and instructions contained in all documents relevant to the product
- Operating the product under incorrect safety or protection conditions
- Altering the product or supplied software without authority
- The product malfunctions due to operating attached or neighboring devices beyond statutory limit values
- In case of unforeseen calamity or force majeure

The use of supplied software produced by SMA Solar Technology AG is subject to the following conditions:

- SMA Solar Technology AG rejects any liability for direct or indirect damages arising from the use of software developed by SMA Solar Technology AG. This also applies to the provision or non-provision of support activities.
- Supplied software not developed by SMA Solar Technology AG is subject to the respective licensing and liability agreements of the manufacturer.

## SMA Factory Warranty

The current guarantee conditions come enclosed with your device. These are also available online at [www.SMA.de](http://www.SMA.de) and can be downloaded or are available on paper from the usual sales channels if required.

## Trademarks

All trademarks are recognized even if these are not marked separately. Missing designations do not mean that a product or brand is not a registered trademark.

The *Bluetooth*<sup>®</sup> word mark and logos are registered trademarks owned by Bluetooth SIG, Inc. and any use of such marks by SMA Solar Technology AG is under license.

### SMA Solar Technology AG

Sonnendallee 1

34266 Niestetal

Germany

Tel. +49 561 9522-0

Fax +49 561 9522-100

[www.SMA.de](http://www.SMA.de)

E-Mail: [info@SMA.de](mailto:info@SMA.de)

© 2004 to 2011 SMA Solar Technology AG. All rights reserved

**SMA Solar Technology**

**www.SMA-Solar.com**

**SMA Solar Technology AG**

[www.SMA.de](http://www.SMA.de)

**SMA America, LLC**

[www.SMA-America.com](http://www.SMA-America.com)

**SMA Technology Australia Pty., Ltd.**

[www.SMA-Australia.com.au](http://www.SMA-Australia.com.au)

**SMA Benelux SPRL**

[www.SMA-Benelux.com](http://www.SMA-Benelux.com)

**SMA Beijing Commercial Co., Ltd.**

[www.SMA-China.com](http://www.SMA-China.com)

**SMA Czech Republic s.r.o.**

[www.SMA-Czech.com](http://www.SMA-Czech.com)

**SMA France S.A.S.**

[www.SMA-France.com](http://www.SMA-France.com)

**SMA Hellas AE**

[www.SMA-Hellas.com](http://www.SMA-Hellas.com)

**SMA Ibérica Tecnología Solar, S.L.**

[www.SMA-Iberica.com](http://www.SMA-Iberica.com)

**SMA Italia S.r.l.**

[www.SMA-Italia.com](http://www.SMA-Italia.com)

**SMA Technology Korea Co., Ltd.**

[www.SMA-Korea.com](http://www.SMA-Korea.com)

