

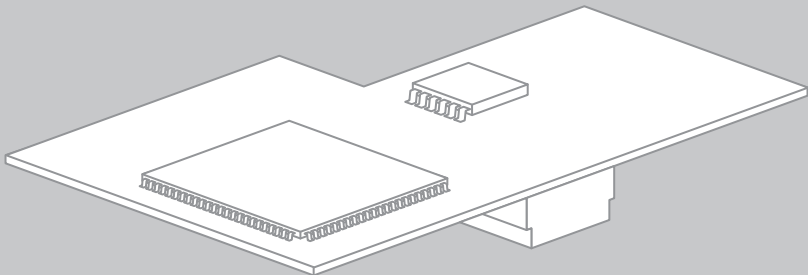

Installation Manual

SMA SPEEDWIRE/WEBCONNECT Piggy-Back



Legal Provisions

The information contained in this document is the property of SMA Solar Technology AG. Publishing its content, either partially or in full, requires the written permission of SMA Solar Technology AG. Any internal company copying of the document for the purposes of evaluating the product or its correct implementation is allowed and does not require permission.

SMA Warranty

You can download the current warranty conditions from the Internet at www.SMA-Solar.com.

Trademarks

All trademarks are recognized, even if not explicitly identified as such. A lack of identification does not mean that a product or symbol is not trademarked.

The BLUETOOTH® word mark and logos are registered trademarks owned by Bluetooth SIG, Inc. and any use of these marks by SMA Solar Technology AG is under license.

Modbus® is a registered trademark of Schneider Electric and is licensed by the Modbus Organization, Inc.

QR Code is a registered trademark of DENSO WAVE INCORPORATED.

Phillips® and Pozidriv® are registered trademarks of Phillips Screw Company.

Torx® is a registered trademark of Acument Global Technologies, Inc.

SMA Solar Technology AG

Sonnenallee 1
34266 Niestetal
Germany

Tel. +49 561 9522-0

Fax +49 561 9522-100

www.SMA.de

E-mail: info@SMA.de

© 2004 to 2014 SMA Solar Technology AG. All rights reserved.

Table of Contents

1	Information on this Document	5
2	Safety	7
2.1	Intended Use	7
2.2	Supported Products	8
2.3	Qualifications of Skilled Persons	8
2.4	Safety Precautions	9
2.5	Operating Information	9
3	Scope of Delivery	10
4	Product Description	11
4.1	SMA Speedwire/Webconnect Piggy-Back	11
4.2	Possible Network Topologies	12
4.3	Type Label	12
4.4	Cable Gland	13
5	Connection	14
5.1	Inverter Connection Area	14
5.2	Cable Requirements and Information on Routing	17
5.3	Connecting the Cable to the Communication Terminal	17
5.4	Installing the Piggy-Back	21
6	Commissioning	22
6.1	Commissioning a Large-Scale PV Plant with Cluster Controller	22
6.2	Commissioning a Small Plant	22
6.3	Managing Small Plants with Sunny Explorer	23
6.3.1	Functions and Parameter Settings in Sunny Explorer	23
6.3.2	Connecting to Sunny Explorer	24
6.4	Plant Registration in Sunny Portal	24
6.4.1	Registering a Small Plant in Sunny Portal	24
6.4.2	Registering a Large-Scale PV Plant with Cluster Controller in Sunny Portal	25

- 7 Decommissioning 26**
 - 7.1 Removing the Piggy-Back..... 26
 - 7.2 Disposing of the Piggy-Back 26
- 8 Troubleshooting 27**
 - 8.1 General Errors..... 27
 - 8.2 Performing a Piggy-Back Update..... 28
- 9 Technical Data 29**
- 10 Contact 30**

1 Information on this Document





Validity

This document is valid for device type "SWPB-10.BG1" from hardware version A and firmware version 1.00.00R.

Target Group

This document is for skilled persons. Only qualified personnel are allowed to perform the tasks described in this manual (see Section 2.3 "Qualifications of Skilled Persons", page 8).

Symbols

Symbol	Explanation
 DANGER	Indicates a hazardous situation which, if not avoided, will result in death or serious injury
 WARNING	Indicates a hazardous situation which, if not avoided, could result in death or serious injury
 CAUTION	Indicates a hazardous situation which, if not avoided, could result in minor or moderate injury
NOTICE	Indicates a situation which, if not avoided, could result in property damage
	Information that is important for a specific topic or goal, but is not safety-relevant
<input type="checkbox"/>	Indicates an essential requirement for achieving a specific goal
<input checked="" type="checkbox"/>	Desired result
x	A problem that might occur

Typography

Typography	Explanation	Example
bold	<ul style="list-style-type: none"> • Display messages • Elements of a user interface • Connections • Elements to be selected • Elements to be entered 	<ul style="list-style-type: none"> • The value can be read from the Energy field. • Select Settings. • Enter the value 10 in the Minutes field.
>	<ul style="list-style-type: none"> • Connects several elements that are to be selected 	<ul style="list-style-type: none"> • Select Settings > Date.
[Button/Key]	<ul style="list-style-type: none"> • Button or key to be selected or pressed 	<ul style="list-style-type: none"> • Select [Next].

Nomenclature

Full designation	Designation in this document
PV plant	Plant
SMA Cluster Controller	Cluster Controller
SMA Speedwire	Speedwire
SMA Speedwire/Webconnect Piggy-Back	Piggy-Back
SMA Webconnect function	Webconnect function
SMA inverter	Inverter

2 Safety

2.1 Intended Use

The Speedwire/Webconnect Piggy-Back is a Speedwire communication interface with Webconnect function for inverters.

Speedwire is a cable-based type of communication based on the Ethernet standard and the communication protocol SMA Data2+. This enables inverter-optimised 10/100 Mbit data transmission between Speedwire devices in PV plants.

The Webconnect function enables data transmission between a small plant and the Internet portal Sunny Portal. In Sunny Portal, a maximum of four inverters can be combined in a Sunny Portal plant.

In Italy, the Speedwire/Webconnect Piggy-Back can be used for plants up to 6 kW that are connected to the low-voltage grid. The Speedwire/Webconnect Piggy-Back implements grid management for one inverter. The Speedwire/Webconnect Piggy-Back also receives specifications from the network operator via Ethernet (in accordance with standard CEI 0-21). The network operator sends the control signals to the Speedwire/Webconnect Piggy-Back via a network operator gateway.

The Speedwire/Webconnect Piggy-Back fulfils the following tasks:

- Set-up of a Speedwire network in small and large-scale PV plants
- Data exchange with Sunny Portal:
 - in small plants via a router with Internet connection
 - in large-scale PV plants via the Cluster Controller
- Data exchange with Sunny Explorer
- Additionally for Italy:
 - Implementation of grid management for one inverter
 - Active power limitation of the connected active power
 - Remote shutdown within 50 ms
 - Narrowing of the frequency limits to between 49.5 Hz and 50.5 Hz
 - Automatic narrowing of the inverter frequency limits to between 49.5 Hz and 50.5 Hz when the connection to the network operator gateway is interrupted

The Speedwire/Webconnect Piggy-Back is available as a retrofit kit.

The inverter still complies with the standard after the product has been installed.

The Speedwire/Webconnect Piggy-Back must only be operated with supported products (see Section 2.2).

For safety reasons, it is not permitted to modify the product or install components that are not explicitly recommended or distributed by SMA Solar Technology AG for this product.

The enclosed documentation is an integral part of this product.

- Read and observe the documentation.
- Keep the documentation in a convenient place for future reference.

Only use the Speedwire/Webconnect Piggy-Back in accordance with the information provided in the enclosed documentation. Any other use may result in personal injury or property damage.

2.2 Supported Products

SMA inverter

The Speedwire/Webconnect Piggy-Back must only be used in the following inverters with at least the given firmware version:

Sunny Boy / Sunny Mini Central	From firmware version
SB 1300TL-10, SB 1600TL-10, SB 2100TL	4.30
SB 3300-11, SB 3800-11	4.02
SMC 6000A-11	4.33
SMC 7000HV-11	2.21

Firmware updates on the inverters can only be carried out by SMA Service. If your inverter is in need of a firmware update, contact the SMA Service Line (see Section 10).

Additional SMA products

- Sunny Explorer from software version 1.05
Sunny Explorer is available free of charge at www.SMA-Solar.com.
- Cluster Controller

2.3 Qualifications of Skilled Persons

The work described in this document must be performed by skilled persons only. Skilled persons must have the following qualifications:

- Training in the installation and commissioning of electrical devices and plants
- Knowledge of how to deal with the dangers and risks associated with installing and using electrical devices and plants
- Knowledge of all applicable standards and directives
- Knowledge of how an inverter works and is operated
- Knowledge of and adherence to this document and all safety precautions

2.4 Safety Precautions

Electric Shock

Lethal voltages are present in the conductive parts of the inverter.

- Prior to performing any work on the inverter, disconnect the inverter from any voltage sources on the AC and DC sides (see inverter installation manual). Observe the waiting time to allow the capacitors to discharge.

Burn Hazards

Some parts of the inverter enclosure can get hot during operation.

- During operation, touch the inverter on the enclosure lid only.

Environmental Influences

When closed and with the ESS plugged in, the inverter has the degree of protection IP65. The inverter is thus protected against dust intrusion and water penetration. Dust intrusion and water penetration can damage the inverter.

- If the ESS is not plugged in, the inverter must be protected against dust and water.
- Firmly plug ESS in again after performing any work on the inverter.

2.5 Operating Information

Selecting a Suitable Internet Tariff for Small Plants

When using the new Webconnect function, a constant Internet connection is required.

Depending on the quality of the Internet connection, the transmission volume for an inverter is between 150 MB and 550 MB per month. When using the plant overview in Sunny Portal with live data display, there is an additional data volume of 600 kB per hour.

- SMA recommends using an Internet tariff with a flat rate.
- Since Sunny Portal is permanently connected to the Internet, time-based billing systems should be avoided. High costs could be incurred.

3 Scope of Delivery

Check the scope of delivery for completeness and any externally visible damage. Contact your specialist dealer if the delivery is incomplete or damaged.

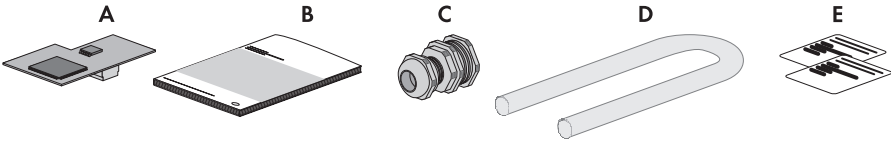

Figure 1: Components included in the scope of delivery

Item	Quantity	Description
A	1	SMA Speedwire/Webconnect Piggy-Back (SWPB-10.BG1)
B	1	Installation manual
C	1	Cable gland
D	1	Silicone tube
E	2	Label with PIC and RID for registration in Sunny Portal

4 Product Description

4.1 SMA Speedwire/Webconnect Piggy-Back

The Speedwire/Webconnect Piggy-Back is a Speedwire communication interface with Webconnect function for inverters.

Speedwire is a cable-based type of communication based on the Ethernet standard and the communication protocol SMA Data2+. This enables inverter-optimised 10/100 Mbit data transmission between Speedwire devices in PV plants.

The Webconnect function enables data transmission between a small plant and the Internet portal Sunny Portal. In Sunny Portal, a maximum of four inverters can be combined in a Sunny Portal plant.

In Italy, the Speedwire/Webconnect Piggy-Back can be used for plants up to 6 kW that are connected to the low-voltage grid. The Speedwire/Webconnect Piggy-Back implements grid management for one inverter. The Speedwire/Webconnect Piggy-Back also receives specifications from the network operator via Ethernet (in accordance with standard CEI 0-21). The network operator sends the control signals to the Speedwire/Webconnect Piggy-Back via a network operator gateway.

The Speedwire/Webconnect Piggy-Back fulfils the following tasks:

- Set-up of a Speedwire network in small and large-scale PV plants
- Data exchange in a large-scale PV plant with Cluster Controller via a router/network switch
- Data exchange with Sunny Portal:
 - in small plants via a router with Internet connection
 - in large-scale PV plants via the Cluster Controller
- Data exchange with Sunny Explorer
- Additionally for Italy:
 - Implementation of grid management for one inverter
 - Active power limitation of the connected active power
 - Remote shutdown within 50 ms
 - Narrowing of the frequency limits to between 49.5 Hz and 50.5 Hz
 - Automatic narrowing of the inverter frequency limits to between 49.5 Hz and 50.5 Hz when the connection to the network operator gateway is interrupted

The Speedwire/Webconnect Piggy-Back is available as a retrofit kit.

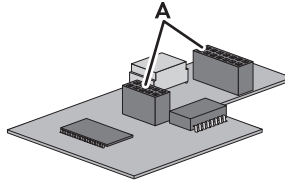

Figure 2: Layout of the SMA Speedwire/Webconnect Piggy-Back

Item	Description
A	Female connector

Label with PIC and RID for Registration of a Small Plant in Sunny Portal

To activate the Piggy-Back in Sunny Portal, you will need the PIC and RID numbers printed on the supplied label. After installation of the Piggy-Back, a label should be affixed on the exterior of the inverter in the vicinity of the type label. Keep the other label in a safe place for future reference.

4.2 Possible Network Topologies

The possible network topologies depend on the devices used and on the number of network ports. The Speedwire/Webconnect Piggy-Back is equipped with one network port. For further information on network topologies, refer to the Technical Information "SMA Speedwire Fieldbus" at www.SMA-Solar.com.

4.3 Type Label

Type Label

The type label clearly identifies the Speedwire/Webconnect Piggy-Back. The type label is located on the front panel of the Speedwire/Webconnect Piggy-Back.

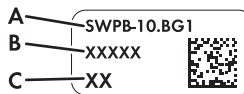

Figure 3: Layout of the type label

Item	Explanation
A	Device type
B	Serial number
C	Hardware version

The information on the type label is required for safe use of the Speedwire/Webconnect Piggy-Back and for reference if customer support from the SMA Service Line is needed. The type label must be permanently affixed to the Speedwire/Webconnect Piggy-Back.

Supplementary Label with Data for Registration in Sunny Portal

The supplementary label is located on the front panel of the Speedwire/Webconnect Piggy-Back. The data for registration in Sunny Portal is to be found on the supplementary labels supplied.

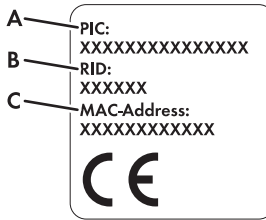

Figure 4: Layout of the supplementary label

Item	Explanation
A	Identification key of the Piggy-Back for registration in Sunny Portal
B	Registration ID of the Piggy-Back for registration in Sunny Portal
C	MAC address of the Piggy-Back

Symbol on the Supplementary label

Symbol	Description	Explanation
	CE marking	The product complies with the requirements of the applicable EU directives.

4.4 Cable Gland

The cable gland provides a sturdy, tightly sealed connection of the network cables with the inverter enclosure. The cable gland also protects the inverter from dust intrusion and moisture penetration.

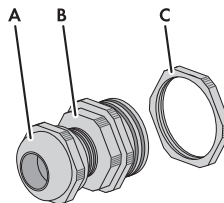

Figure 5: Product description: Cable gland

Item	Description
A	Swivel nut
B	Adaptor PG16 to M16
C	Counter nut

5 Connection

5.1 Inverter Connection Area

SB 1300TL-10, SB 1600TL-10, SB 2100TL

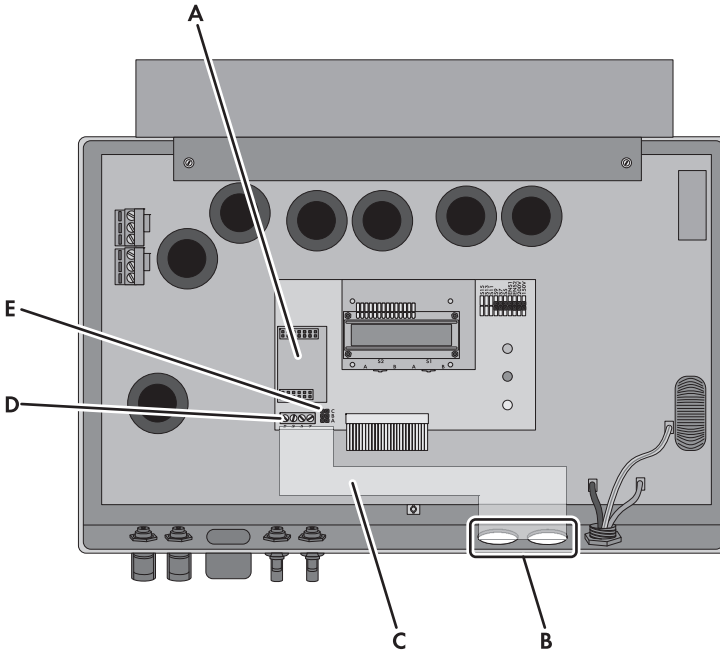

Figure 6: Overview of the connection area

Item	Description
A	Slot for Piggy-Back
B	Opening in the inverter enclosure with filler plug
C	Cable route to communication terminal
D	Communication terminal
E	Jumper slot for communication

SB 3300-11, SB 3800-11

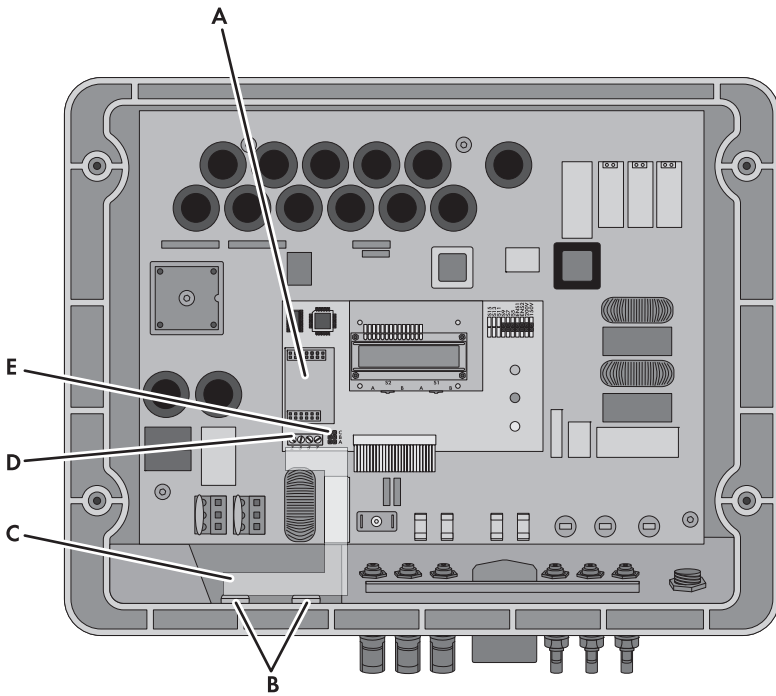

Figure 7: Overview of the connection area

Item	Description
A	Slot for Piggy-Back
B	Opening in the inverter enclosure with filler plug
C	Cable route to communication terminal
D	Communication terminal
E	Jumper slot for communication

SMC 6000A-11, SMC 7000HV-11

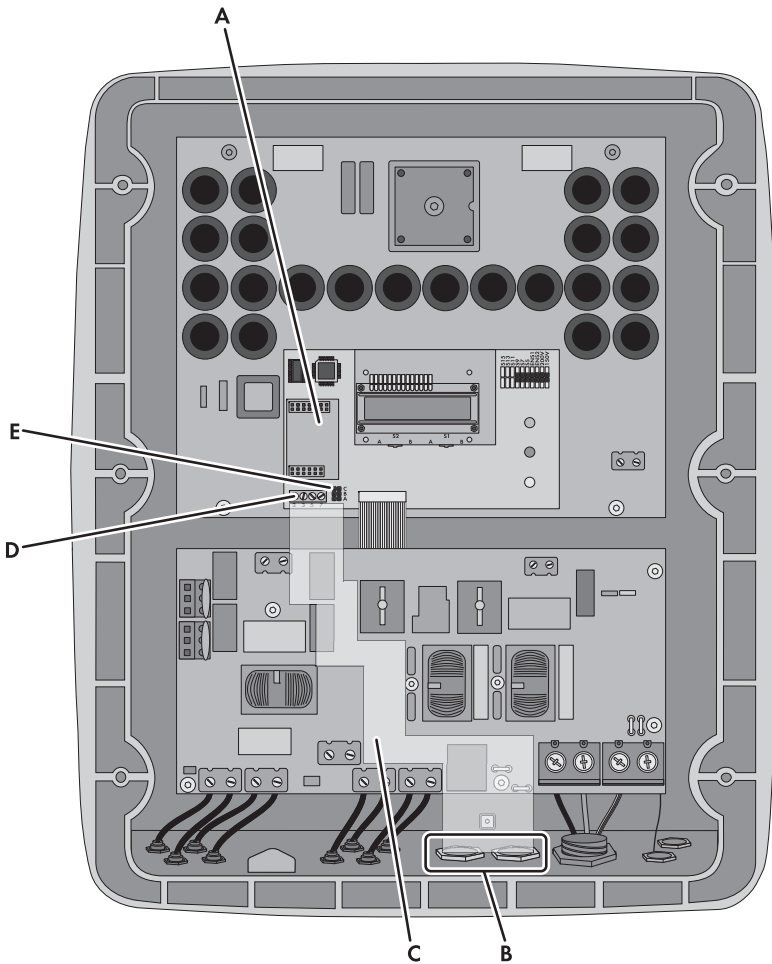

Figure 8: Overview of the connection area

Item	Description
A	Slot for Piggy-Back
B	Opening in the inverter enclosure with filler plug
C	Cable route to communication terminal
D	Communication terminal
E	Jumper slot for communication

5.2 Cable Requirements and Information on Routing

The cable length and quality have an effect on the signal quality in the Speedwire network. Observe the following information and cable requirements:

Disturbance of data transmission due to AC Cables

When AC cables are in operation, they generate an electromagnetic field which may induce interference in network cables during data transmission.

- Lay the network cables using suitable fastening material and with a minimum clearance of 50 mm to the AC cables.

Cable requirements

- Cable length between two nodes: max. 100 m
- Cross-section: at least $2 \times 2 \times 0.22 \text{ mm}^2$ or at least 2x2 AWG 24
- Cable type: 100BaseTx, CAT5 with shielding S-UTP, F-UTP or higher
- UV-resistant for outdoor use
- Type of plug: RJ45

SMA Solar Technology AG recommends the following cable types:

- For outdoor use: SMA COMCAB-OUTxxx
- For indoor use: SMA COMCAB-INxxx

The cables are available in the lengths xxx = 100 m, 200 m, 500 m, 1,000 m

5.3 Connecting the Cable to the Communication Terminal

Figures in this section

The work steps in this section are supported by figures of the inverter types SB 3300-11 and SB 3800-11. The procedure for other inverter types is analogous (see Section 5.1).

Requirement:

- For Italy: There must be an available network operator gateway with network connection for telecontrol protocol IEC 61850.

Additionally required material (not included in the scope of delivery):

- 1 network cable (see Section 5.2)
- 4 bootlace ferrules
- 1 RJ45 connector

Procedure:1. **⚠ DANGER****Danger to life due to electric shock when opening the inverter**

Lethal voltages are present in the conductive parts of the inverter.

- Disconnect the inverter from any voltage sources on the AC and DC sides (see the inverter installation manual). Observe the waiting time to allow the capacitors to discharge.

2. Open the inverter (see inverter installation manual).
3. Push one filler plug from the inside out of the bottom of the inverter enclosure.
4. Attach the cable gland to the enclosure opening using the counter nut. Ensure that the grooved side of the counter nut is facing the inverter enclosure.

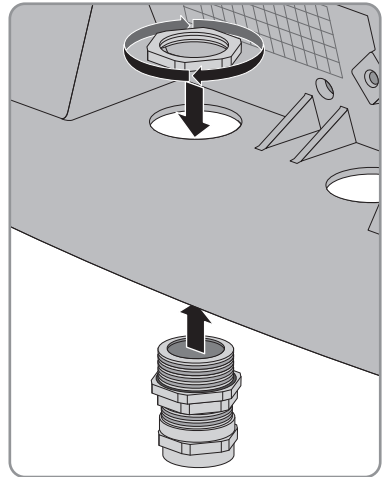

5. Gauge the length from the communication terminal to the counter nut on the cable gland using the cable, and mark the position on the cable. Be sure to take the permitted cable route into account (see Section 5.1).
6. Below the marked position, remove 20 mm from the cable sheath. This will enable contact between the screening clamp and the cable shield in the cable gland.

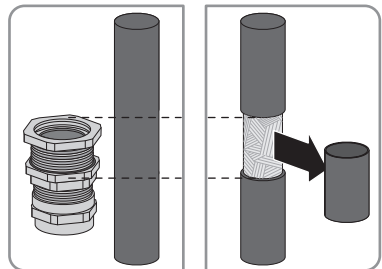

7. Unscrew the swivel nut of the cable gland but do not remove it.

8. Gradually guide the end of the cable through the cable gland into the inverter, until you can hear the screening clamp grip onto the cable shield.

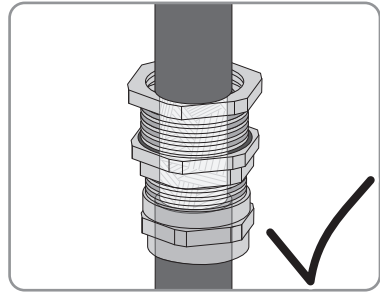

9. Tighten the swivel nut of the cable gland. This will prevent the cable from slipping and the contact between screening clamp and cable shield being lost.
10. At the end of the cable, remove 40 mm from the cable sheath and cable shield. Make sure that no pieces of cable are dropped into the inverter.
11. At the end of the cable, strip the insulation of the four required wires by 6 mm. Take the type of cable into account, as listed below:

Network cable		
Signal	EIA/TIA 568A (8-wire) Wire colour	Profinet (4-wire) Wire colour
TD+	white/green	yellow
TD-	green	orange
RD+	white/orange	white
RD-	orange	blue

12. Shorten all other wires flush with the cable sheath.
13. Attach the bootlace ferrules to the wire ends.

14. **⚠ DANGER**

Danger to life due to electric shock in case of incorrect cable insulation

If a cable is not correctly insulated, high voltages may occur on the cable outside the inverter.

- Lead the cable into the inverter through the silicone tube. The silicone tube must completely cover the cable and the wires inside the inverter enclosure.
- Cut the silicone tube to the required length, as necessary.
- Fix the silicone tube in position with cable ties at the beginning and end of the cable, as necessary. Trim the ends of the cable ties. This will prevent the ends of the cable ties causing damage to hot components in the inverter.

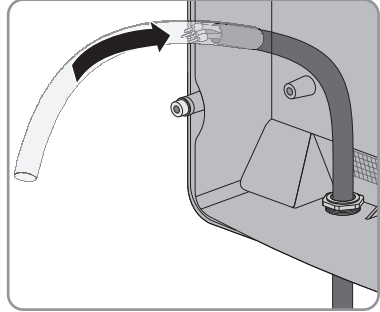

15. Connect the wire ends to the communication terminal in the inverter at screw terminals **2, 3, 5** and **7** (torque: 0.23 Nm) (for position of the communication terminal, see Section 5.1). Observe the permitted cable route (see Section 5.1) and the pin assignment as follows:

Inverter communication terminal	Network cable		
	Signal	EIA/TIA 568A (8-wire) Wire colour	Profinet (4-wire) Wire colour
2	TD+	white/green	yellow
3	TD-	green	orange
7	RD+	white/orange	white
5	RD-	orange	blue

16. Make sure that there are no jumpers in the communication jumper slot (position of jumper slot for communication, see Section 5.1).

17. Attach an RJ45 connector to the other end of the cable (see manufacturer's manual). Observe the pin assignment of the network cable, as follows:

Network cable			
Signal	Pin RJ45 plug	EIA/TIA 568A (8-wire) Wire colour	Profinet (4-wire) Wire colour
TD+	1	white/green	yellow
TD-	2	green	orange
RD+	3	white/orange	white
RD-	6	orange	blue

18. Subject to the required network topology, connect the other end of the cable to a router, network switch or Cluster Controller (see manual of the respective device). To do this, a router with Internet connection must be connected to the plant.

5.4 Installing the Piggy-Back

1. **⚠ DANGER**

Danger to life due to electric shock when opening the inverter

Lethal voltages are present in the conductive parts of the inverter.

- If the inverter is closed, proceed as follows:
 - Disconnect the inverter from any voltage sources on the AC and DC sides (see the inverter installation manual). Observe the waiting time to allow the capacitors to discharge.
 - Open the inverter (see inverter installation manual).

2. Plug the Piggy-Back into the female connectors at the slot in the inverter (for position of slot, see Section 5.1).

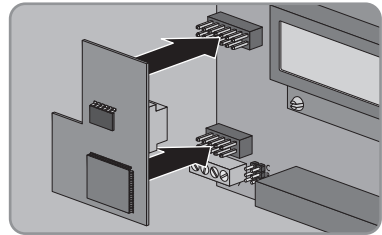

3. Stick one of the labels with the data for registration in Sunny Portal (PIC and RID) on the outside of the inverter in the vicinity of the type label.
4. Close the inverter (see inverter installation manual).

6 Commissioning

6.1 Commissioning a Large-Scale PV Plant with Cluster Controller

Requirements:

- The cable must be connected to the communication terminal (see Section 5.3).
- The Piggy-Back must be installed in the inverter (see Section 5.4).
- Subject to the required network topology, the Cluster Controller must be connected to the Speedwire network (see Cluster Controller installation manual).

Procedure:

1. Commission all inverters with installed Piggy-Back (see inverter installation manual).

2.  **Deactivating the Webconnect function of the inverters**

In a large-scale PV plant with Cluster Controller, communication with Sunny Portal takes place via the Cluster Controller itself.

For optimal operation of large-scale PV plants with Cluster Controller, deactivate the factory-activated Webconnect function of the inverter with installed Piggy-Back (see Cluster Controller user manual).

6.2 Commissioning a Small Plant

Requirements:

- The cable must be connected to the communication terminal (see Section 5.3).
- The Piggy-Back must be installed in the inverter (see Section 5.4).
- The plant must be connected to a router with Internet connection.
- DHCP must be enabled for the router.
- For Italy, in order to adjust the Sunny Explorer settings for receiving control signals from the Piggy-Back, you must have a personal SMA Grid Guard code (see Sunny Explorer help).

Procedure:

1. Commission all inverters with installed Piggy-Back (see inverter installation manual).
2. For plants in Italy, in order to adjust the settings to receive control signals from the network operator in the Piggy-Back, follow the steps below:
 - Connect to Sunny Explorer (see Section 6.3.2).
 - Enter your personal SMA Grid Guard code in Sunny Explorer (see Sunny Explorer help).

- Set the following parameters in Sunny Explorer (for setting parameters in a device, see Sunny Explorer help):

External Communication > IEC 61850 configuration			
Parameter	Value/Range	Resolution	Default
Application-ID	0 to 0x4000	1	0x4000
Goose-Mac address	01:0C:CD:01:00:00 ... 01:0C:CD:01:02:00	1	01:0C:CD:01:02:00

- In the field **Application-ID**, enter the Application-ID of the network operator gateway. You will receive this value from your network operator. You can enter a value between **0** and **16384**. The value **16384** indicates deactivation.
- In the field **Goose-Mac address**, enter the MAC address of the network operator gateway from which the Piggy-Back is to receive control commands. You will receive this value from your network operator. If all MAC addresses are to be accepted in the adjustable domain, enter **01:0C:CD:01:02:00**.

6.3 Managing Small Plants with Sunny Explorer

6.3.1 Functions and Parameter Settings in Sunny Explorer

The following functions for plant management in Sunny Explorer are available:

- Overview of the plant status
- Graphic display of key plant data, device data and energy values
- Parameterisation of individual devices or an entire device class
- Simple diagnostics thanks to the display of faults and events
- Data export of inverter energy values and events in CSV format
- Piggy-Back update

You can change the following parameters in Sunny Explorer:

- Device name of the inverter
- Automatic IP configuration On/Off
- DNS-IP, gateway IP, IP address, subnet mask
- Webconnect function On/Off
- IEC 61850 configuration for plants in Italy up to 6 kW

6.3.2 Connecting to Sunny Explorer

Requirements:

- The plant must be commissioned (see Section 6.2).
- The inverter with Piggy-Back must be in feed-in operation.

Procedure:

1. Connect the computer to the router/network switch with a network cable.
2. Start Sunny Explorer and create a plant (see Sunny Explorer help).

6.4 Plant Registration in Sunny Portal

6.4.1 Registering a Small Plant in Sunny Portal

Requirements:

- The small plant must be commissioned (see Section 6.2).
- The inverter with Piggy-Back must be in feed-in operation.
- The plant must be connected to a router with permanent Internet connection (see router manual).
- PIC and RID must be available for the Piggy-Back.
- Your computer must have an Internet connection.
- JavaScript must be activated in the Internet browser.

Maximum permissible number of devices for a small plant in Sunny Portal

In Sunny Portal you can manage several plants. A maximum of four inverters with integrated Piggy-Back is permissible per small plant.

Small plant with Piggy-Back cannot be combined with other plants

If you have already registered a plant in Sunny Portal with another communication device, e.g. Sunny WebBox, you will still need to create a separate small plant with Piggy-Back. It is not possible to combine the Piggy-Back and other communication devices within one plant in Sunny Portal. Sunny Portal treats the existing plant and the new small plant with Piggy-Back as separate plants.

- Create a new small plant with Piggy-Back.

Starting the Plant Setup Assistant in Sunny Portal

The Plant Setup Assistant is a step-by-step guide of the processes required for user registration and the registration of your plant in Sunny Portal.

1. Open www.SunnyPortal.com.
2. Select [**Plant Setup Assistant**].
 - The Plant Setup Assistant opens.
3. Follow the instructions of the Plant Setup Assistant.

6.4.2 Registering a Large-Scale PV Plant with Cluster Controller in Sunny Portal

Requirements:

- The large-scale PV plant with Cluster Controller must be commissioned (see Section 6.1).
- The inverter with Piggy-Back must be in feed-in operation.
- The Cluster Controller must be connected to a router with Internet connection (see Cluster Controller installation manual).
- Your computer must have an Internet connection.
- JavaScript must be activated in the Internet browser.

Procedure:

- For large-scale PV plants with Cluster Controller, register in Sunny Portal using the Cluster Controller user interface (see Cluster Controller user manual).

7 Decommissioning

7.1 Removing the Piggy-Back

1. **⚠ DANGER**

Danger to life due to electric shock when opening the inverter

Lethal voltages are present in the conductive parts of the inverter.

- Disconnect the inverter from any voltage sources on the AC and DC sides (see the inverter installation manual). Observe the waiting time to allow the capacitors to discharge.
2. Open the inverter (see inverter installation manual).
 3. Remove the Piggy-Back from the communication interface.

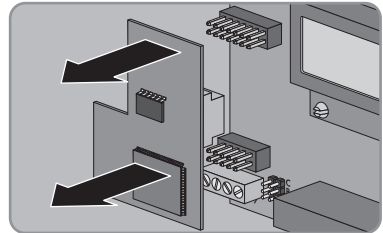

4. Release the screw terminals at the communication terminal in the inverter and remove the wires.
5. Remove the silicone tube from the cable.
6. Unscrew the swivel nut of the cable gland.
7. Pull the cable out of the inverter.
8. Unscrew the counter nut of the cable gland and remove the cable gland.
9. Seal the enclosure opening of the inverter with the corresponding filler plug.
10. Close the inverter (see inverter installation manual).

7.2 Disposing of the Piggy-Back

- Dispose of the Piggy-Back in accordance with the regulations for the disposal of electronic waste applicable at the installation site.

8 Troubleshooting

8.1 General Errors

Problem	Cause and corrective measures
The inverter with Piggy-Back cannot be accessed.	<p data-bbox="408 272 728 300">There is no Speedwire connection.</p> <p data-bbox="408 316 632 343">Corrective measures:</p> <ul data-bbox="431 351 1010 576" style="list-style-type: none"> <li data-bbox="431 351 1010 378">• Ensure that all network cable plugs are inserted and locked. <li data-bbox="431 386 1010 413">• Ensure that all inverters in the plant are in operation. <li data-bbox="431 421 1010 448">• Ensure that the plant router is switched on. <li data-bbox="431 456 1010 515">• Ensure that the Piggy-Back is connected correctly (see Section 5.3). <li data-bbox="431 523 1010 576">• Ensure that the Cluster Controller is connected to the local plant network (see Cluster Controller installation manual).
	<p data-bbox="408 576 884 635">The firmware version of the inverter is not supported (see Section 2.2).</p> <p data-bbox="408 643 632 670">Corrective measures:</p> <ul data-bbox="431 678 1010 767" style="list-style-type: none"> <li data-bbox="431 678 1010 767">• An inverter firmware update can only be carried out by SMA Service. If your inverter is in need of a firmware update, contact the SMA Service Line (see Section 10).
	<p data-bbox="408 767 1010 799">The software version of Sunny Explorer is older than version 1.05.</p> <p data-bbox="408 807 632 834">Corrective measures:</p> <ul data-bbox="431 842 1010 903" style="list-style-type: none"> <li data-bbox="431 842 1010 903">• Download Sunny Explorer from software version 1.05 from www.SMA-Solar.com and install.
	<p data-bbox="408 903 795 935">Firewall or IP filter settings are not correct.</p> <p data-bbox="408 943 632 970">Corrective measures:</p> <ul data-bbox="431 978 1010 1046" style="list-style-type: none"> <li data-bbox="431 978 1010 1046">• Adjust the firewall or IP filter settings (see firewall or router manual).
	<p data-bbox="408 1046 862 1078">The Piggy-Back does not have a valid IP address.</p> <p data-bbox="408 1086 632 1114">Corrective measures:</p> <ul data-bbox="431 1121 1010 1158" style="list-style-type: none"> <li data-bbox="431 1121 1010 1158">• Make sure DHCP is enabled for the router.
	<p data-bbox="408 1158 968 1254">Inverters with retrofitted Piggy-Back shut down overnight. It is therefore not possible to establish any connection to these inverters.</p> <p data-bbox="408 1262 974 1326">As soon as the inverters switch on in the morning, they will be accessible again.</p>
Piggy-Back update does not initialise.	<p data-bbox="408 1326 879 1358">The feed-in power of the inverter is less than 50 W.</p> <p data-bbox="408 1366 632 1393">Corrective measures:</p> <ul data-bbox="431 1401 1010 1461" style="list-style-type: none"> <li data-bbox="431 1401 1010 1461">• Carry out update once the feed-in power of the inverter is at least 50 W.

8.2 Performing a Piggy-Back Update

Piggy-Back updates are performed via Sunny Explorer. There is no need to replace the Piggy-Back. Existing inverter settings and data are retained after the update. Only carry out an update providing that the feed-in power of the inverter is sufficient (at least 50 W). After a successful update, restart Sunny Explorer.

9 Technical Data

General Data

Mounting location	in the inverter
Voltage supply	via the inverter

Mechanical Data

Width x height x depth	50 mm x 81 mm x 12 mm
------------------------	-----------------------

Communication

Communication interface	Speedwire/Webconnect
Maximum cable length	100 m

Ambient Conditions for Storage/Transport

Ambient temperature	- 40 °C to +70 °C
Relative humidity, non-condensing	5% to 95%
Maximum height above sea level (MSL)	3,000 m

10 Contact

If you have technical problems concerning our products, contact the SMA Service Line. We require the following information in order to provide you with the necessary assistance:

- Type, serial number and firmware version of the inverter
- Type, serial number and firmware version of the Piggy-Back
- For large-scale PV plants: serial number and firmware version of the Cluster Controller
- For small plants: PIC and RID of the Piggy-Back

Australia	SMA Australia Pty Ltd. Sydney	Toll free for Australia:	1800 SMA AUS (1800 762 287)
		International:	+61 2 9491 4200
Belgien/ Belgique/ België	SMA Benelux BVBA/SPRL Mechelen	+32 15 286 730	
Brasil	Vide Espanha (Espanha)		
Česko	SMA Central & Eastern Europe s.r.o. Praha	+420 235 010 417	
Chile	Ver España		
Danmark	Se Deutschland (Tyskland)		
Deutschland	SMA Solar Technology AG Niestetal	Medium Power Solutions Wechselrichter: Kommunikation: SMA Online Service Center: www.SMA.de/Service Hybrid Energy Solutions Sunny Island: PV-Diesel Hybridsysteme: Power Plant Solutions Sunny Central:	+49 561 9522-1499 +49 561 9522-2499 +49 561 9522-399 +49 561 9522-3199 +49 561 9522-299
España	SMA Ibérica Tecnología Solar, S.L.U. Barcelona	Llamada gratuita en España: Internacional:	900 14 22 22 +34 902 14 24 24
France	SMA France S.A.S. Lyon	Medium Power Solutions Onduleurs : Communication : Hybrid Energy Solutions Sunny Island : Power Plant Solutions Sunny Central :	+33 472 09 04 40 +33 472 09 04 41 +33 472 09 04 42 +33 472 09 04 43

India	SMA Solar India Pvt. Ltd. Mumbai	+91 22 61713888
Italia	SMA Italia S.r.l. Milano	+39 02 8934-7299
Κύπρος/ Kıbrıs	Βλέπε Ελλάδα/ Bkz. Ελλάδα (Yunanistan)	
Luxemburg/ Luxembourg	Siehe Belgien Voir Belgique	
Magyarország	lásd Česko (Csehország)	
Nederland	zie Belgien (België)	
Österreich	Siehe Deutschland	
Perú	Ver España	
Polska	Patrz Česko (Czechy)	
Portugal	SMA Solar Technology Portugal, Unipessoal Lda Lisboa	Gratuito em Portugal: 800 20 89 87 Internacional: +351 2 12 37 78 60
România	Vezi Česko (Cehia)	
Schweiz	Siehe Deutschland	
Slovensko	pozri Česko (Česká republika)	
South Africa	SMA Solar Technology South Africa Pty Ltd. Centurion (Pretoria)	08600 SUNNY (08600 78669) International: +27 (12) 643 1785
United Kingdom	SMA Solar UK Ltd. Milton Keynes	+44 1908 304899
Ελλάδα	SMA Hellas AE Αθήνα	801 222 9 222 International: +30 212 222 9 222
България	Вижте Ελλάδα (Гърция)	
ไทย	SMA Solar (Thailand) Co., Ltd. ประเทศไทย	+66 2 670 6999
대한민국	SMA Technology Korea Co., Ltd. 서울	+82 2 508-8599

+971 2 234-6177

SMA Middle East LLC

أبو ظبي

الإمارات
العربية المتحدة

Other countries

International SMA Service Line
NiestetalToll free worldwide: 00800 SMA SERVICE
(+800 762 7378423)

SMA Solar Technology

www.SMA-Solar.com

