

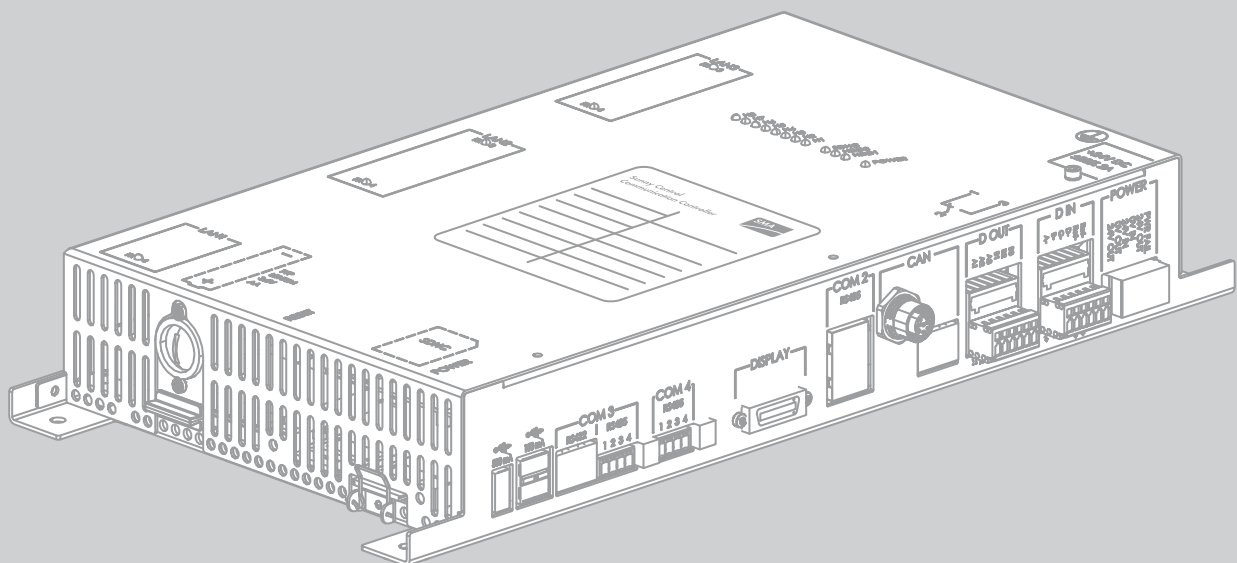

Operating Manual

# SUNNY CENTRAL COMMUNICATION CONTROLLER



## Legal Provisions

The information contained in this document is the property of SMA Solar Technology AG. Publishing its content, either partially or in full, requires the written permission of SMA Solar Technology AG. Any internal company copying of the document for the purposes of evaluating the product or its correct implementation is allowed and does not require permission.

### SMA Manufacturer's Warranty

You can download the current warranty conditions from the Internet at [www.SMA-Solar.com](http://www.SMA-Solar.com).

### Trademarks

All trademarks are recognised even if these are not marked separately. Missing designations do not mean that a product or brand is not a registered trademark.

The *Bluetooth*<sup>®</sup> word mark and logos are registered trademarks owned by Bluetooth SIG, Inc. and any use of such marks by SMA Solar Technology AG is under licence.

QR Code<sup>®</sup> is a registered trademark of DENSO WAVE INCORPORATED.

### SMA Solar Technology AG

Sonnenallee 1  
34266 Niestetal  
Germany

Tel. +49 561 9522-0  
Fax +49 561 9522-100  
[www.SMA.de](http://www.SMA.de)  
E-mail: [info@SMA.de](mailto:info@SMA.de)

© 2004 to 2013 SMA Solar Technology AG. All rights reserved

# Table of Contents

<b>1</b>	<b>Information on this Document</b>	<b>5</b>
<b>2</b>	<b>Safety</b>	<b>7</b>
2.1	Appropriate Usage	7
2.2	Target Group Qualifications	7
2.3	Safety Precautions	7
<b>3</b>	<b>Product Description</b>	<b>9</b>
3.1	SC-COM	9
3.2	Network Concept	10
3.3	LEDs of the SC-COM	11
3.3.1	LEDs on the Enclosure	11
3.3.2	LEDs on the Network Terminal	12
3.3.3	LEDs on the Optical Fibre Terminals	13
3.4	User Interface	14
3.4.1	Design	14
3.4.2	Structural View and Device View	14
3.5	Type Label and Firmware Version	15
<b>4</b>	<b>Logging In and Out of the User Interface</b>	<b>16</b>
4.1	Logging Into the User Interface	16
4.2	Logging Out of the User Interface	16
<b>5</b>	<b>Commissioning</b>	<b>17</b>
5.1	Sequence for Commissioning	17
5.2	Configuring the Network Settings on the Computer	17
5.3	Setting the Language and Time	17
5.4	Configuring the SC-COM for the Local Network	18
5.4.1	Information on Integrating the SC-COM into a Local Network	18
5.4.2	Configuring the SC-COM for a Static Network	18
5.4.3	Configuring the SC-COM for Dynamic Networks	18
5.4.4	Adjusting Network Ports	19
5.5	Detecting Devices	20
5.6	Parameterising the Devices	20
5.7	Deleting Device Descriptions	20
<b>6</b>	<b>Setting the SC-COM</b>	<b>21</b>
6.1	Configuring Security Settings	21
6.1.1	Changing the Password	21
6.1.2	Deactivating the RPC Interface	21
6.2	Configuring System Settings	22
6.2.1	Setting the Date, Time and Time Zone	22
6.2.2	Setting the Language	22
6.2.3	Entering the Operator Name	22
6.2.4	Resetting the SC-COM	22
6.2.5	Restarting the SC-COM	23

6.3	Customer-Specific Settings via XML File	24
6.3.1	Uploading the custom.xml File	24
6.3.2	Downloading the XML File custom.xml	24
6.3.3	Deleting the custom.xml File	25
<b>7</b>	<b>Managing Data</b>	<b>26</b>
7.1	Setting the Averaging	26
7.2	Setting the Data Transmission Frequency	26
7.3	Setting Data Communication with Sunny Portal	27
7.3.1	Registering the SC-COM in Sunny Portal	27
7.3.2	Adjusting the Plant Identifier for Sunny Portal	27
7.3.3	Deleting the Sunny Portal Buffer	27
7.4	Setting Data Communication with the FTP Server	28
7.4.1	Defining Read and Write Access Rights for the FTP Server	28
7.4.2	Calling up the FTP Server via the Internet Browser	28
7.4.3	Setting and Testing the FTP Push Function	29
7.5	Making Settings for Modbus Communication	30
7.5.1	Managing Modbus Profiles	30
7.5.2	Changing the Unit ID	30
7.6	Downloading Data via HTTP	31
7.6.1	Downloading Data in XML Format	31
7.6.2	Downloading Data in CSV Format	31
7.7	Storing Data on the Memory Card	33
7.7.1	Information on Saving Data on a Memory Card	33
7.7.2	Inserting the Memory Card	33
7.7.3	Enabling and Disabling Data Storage on the Memory Card	33
7.8	Determining Available Memory Space	34
7.9	Displaying and Downloading the Event Report	34
7.10	Activating Alert in the Event of a Fault	35
<b>8</b>	<b>Updating the Firmware</b>	<b>36</b>
8.1	Information on Updating the Firmware	36
8.2	Enabling Automatic Firmware Updates	36
8.3	Updating the Firmware via the User Interface	36
<b>9</b>	<b>Troubleshooting</b>	<b>37</b>
9.1	Error Overview	37
9.2	Sending ZIP File with Service Information	39
<b>10</b>	<b>Appendix</b>	<b>40</b>
10.1	User Groups	40
10.2	XML File custom.xml	40
10.2.1	Structure of the XML File custom.xml	40
10.2.2	Parameters and Values for the custom.xml File	41
10.3	Plant Presentation in Sunny Portal	43
10.4	Accessing the SC-COM via Sunny Portal	43
<b>11</b>	<b>Technical Data</b>	<b>44</b>
<b>12</b>	<b>Contact</b>	<b>45</b>

# 1 Information on this Document

## Validity

This document is valid for the Sunny Central Communication Controller device type with hardware version E1 and firmware version 1.04 or higher.

## Target Group









This document is intended for skilled persons. Only persons with the appropriate skills are allowed to perform the tasks described in this document (see Section 2.2 "Target Group Qualifications", page 7).

## Additional Information

Additional information is available at [www.SMA-Solar.com](http://www.SMA-Solar.com):

Document title	Document type
Plant Communication in Large-Scale PV Plants - Basic Principle of Plant Communication	Technical description
Setting up the Local FTP Server - Configuring a Local FTP Server for the Receipt of the PV Plant Data via the FTP Push Function of the SUNNY WEBBOX.	Technical information
SUNNY PORTAL	User manual
Interface for Modbus-Communication SUNNY WEBBOX / SC-COM Modbus <sup>®</sup> Interface	Technical description
SUNNY WEBBOX RPC	User manual

## Symbols

Symbol	Explanation
	Indicates a hazardous situation which, if not avoided, will result in death or serious injury
	Indicates a hazardous situation which, if not avoided, can result in death or serious injury
	Indicates a hazardous situation which, if not avoided, can result in minor or moderate injury
	Indicates a situation which, if not avoided, can result in property damage
	Information that is important for a specific topic or objective, but is not safety-relevant
	Indicates a requirement for meeting a specific goal
	Desired result
	A problem that might occur

## Typography

Typography	Usage	Example
<b>Bold</b>	<ul style="list-style-type: none"> <li>• Display messages</li> <li>• Elements of a user interface</li> <li>• Parameters</li> <li>• Terminals</li> <li>• Slots</li> <li>• Elements to be selected</li> <li>• Elements to be entered</li> </ul>	<ul style="list-style-type: none"> <li>• Select the <b>ExlTrfErrEna</b> parameter and set to <b>Off</b>.</li> <li>• Select the <b>Parameters</b> tab.</li> </ul>
<b>&gt;</b>	<ul style="list-style-type: none"> <li>• Connects several elements to be selected</li> </ul>	<ul style="list-style-type: none"> <li>• Select <b>Plant &gt; Detect</b>.</li> </ul>
<b>[Button/Key]</b>	<ul style="list-style-type: none"> <li>• Button or key to be selected or pressed</li> </ul>	<ul style="list-style-type: none"> <li>• Select <b>[Start detection]</b>.</li> </ul>

## Nomenclature

In this manual, the Sunny Central Communication Controller is referred to as SC-COM.

## Abbreviations

Abbreviation	Designation	Explanation
CR	Carriage Return	Control character starting a new line of text
CRLF	Carriage Return and Line Feed	-
CSV	Comma-Separated Values	File format
DHCP	Dynamic Host Configuration Protocol	Protocol for the dynamic assignment of IP configurations
FTP	File Transfer Protocol	Network protocol for data transmission
HTTP	Hypertext Transfer Protocol	Protocol for data transmission via a network
IP	Internet Protocol	-
LAN	Local Area Network	-
LED	Light-Emitting Diode	-
LF	Line Feed	Control character signifying the end of a line of text
OF	Optical Fibre	-
RPC	Remote Procedure Call	Technique enabling inter-procedural communication
TCP	Transmission Control Protocol	Transport protocol for packet-switching in connection-oriented networks
URL	Uniform Resource Locator	-
UPS	Uninterruptible Power Supply	-
UTC	Universal Time Coordinated	-
XML	Extensible Markup Language	Extensible Markup Language

## 2 Safety

### 2.1 Appropriate Usage

The Sunny Central Communication Controller (SC-COM) is the central communication interface of the Sunny Central. The SC-COM establishes the connection between the Sunny Central and the operator.

The SC-COM is used in the Sunny Central of the CP XT and the CP-US production series.

The SC-COM may only be used in accordance with the specifications of this manual. Any other use may result in personal injury or property damage.

The data collected by the SC-COM can deviate from the data of the energy meter. The SC-COM data must not be used for billing purposes.

The enclosed documentation is an integral part of the product.

- Read and follow the documentation to ensure proper and optimum use of the SC-COM.
- Keep the documentation in a convenient place for future reference.

### 2.2 Target Group Qualifications

The tasks described in this manual may be performed by qualified persons only. Skilled persons must have the following qualifications:

- Knowledge of how the device works and is operated
- Knowledge of how to deal with the dangers and risks associated with installing and using electrical devices
- Training in the installation and commissioning of electrical devices
- Training in the installation and configuration of IT systems
- Knowledge of all applicable standards and directives
- Knowledge of and adherence to this manual and all safety precautions

Skilled persons must be authorised to modify grid-relevant parameters of connected devices.

The SC-COM distinguishes between two user groups: user and installer (see Section 10.1, page 40).

### 2.3 Safety Precautions

#### **NOTICE**

#### **Damage to electronic components due to electrostatic discharge**

Electrostatic discharge can damage or destroy electronic components.

- Observe the ESD safety regulations when working on the device.
- Wear suitable personal protective equipment for all work on the inverter.
- Discharge the electrostatic charge by touching uncoated, earthed enclosure parts (e.g. at the PE connection on the doors). Only then is it safe to touch any electronic components.

** Data security**

The SC-COM can be connected to the Internet. Note that connecting to the Internet carries the risk that unauthorised users can gain access to and manipulate your data.

- Change the password after your first login.
- Make sure you use a high-strength password.
- Change your passwords at regular intervals.
- Protect your password from access by unauthorised users.
- Never leave slips of paper with passwords lying around.
- Set up a firewall.
- Close unnecessary network ports.



## 3 Product Description

### 3.1 SC-COM

The Sunny Central Communication Controller (SC-COM) is the central communication interface of the Sunny Central. The SC-COM establishes the connection between the Sunny Central and the operator.

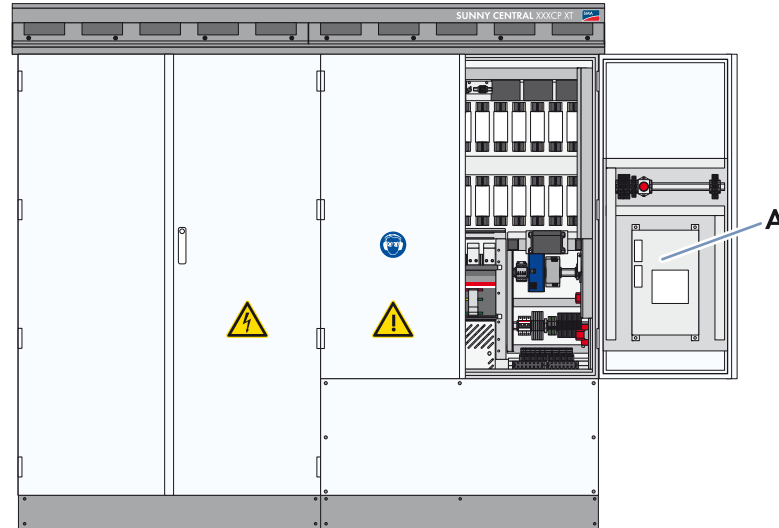

Figure 1: Position of the SC-COM in the Sunny Central (using the Sunny Central of the CP XT production series)

Position	Designation
A	SC-COM

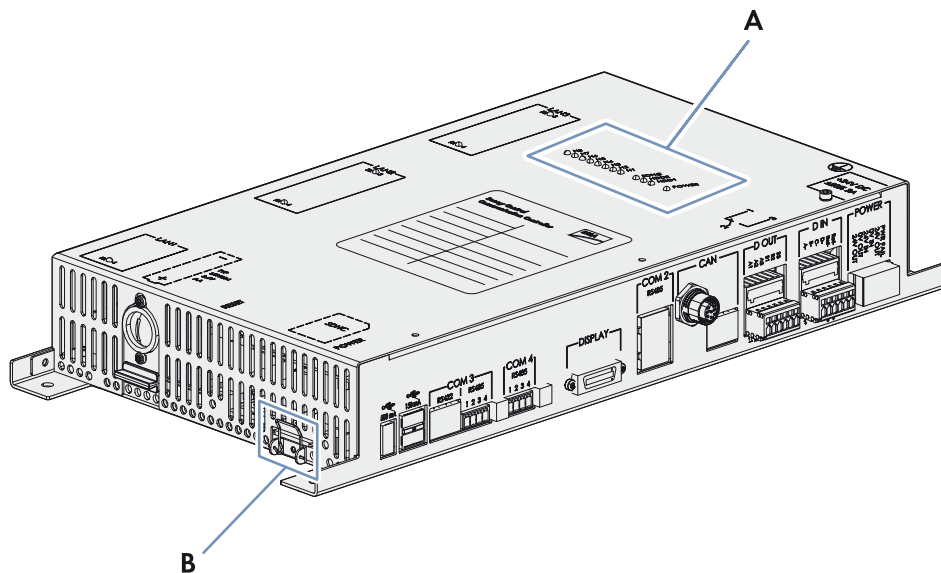

Figure 2: Design of the SC-COM

Position	Designation
A	LEDs
B	Slot for the external memory card

The SC-COM collects all data from the connected devices. The SC-COM enables monitoring, parameterisation and remote diagnosis of the Sunny Central via computer, as well as power control of the Sunny Central by the network operator.

The SC-COM is equipped with serial interfaces to ensure the availability of these functions. These include, for example:

- Three LAN interfaces
- RS485 interface for communication with devices used for string-current monitoring
- Interfaces for the communication with internal inverter components

These SC-COM interfaces are wired during production. When installing the Sunny Central, connect the external data cables to the customer connection terminals in the Sunny Central.

### 3.2 Network Concept

In order to transmit the data faster and more efficiently, the SC-COM is equipped with two additional LAN interfaces. This enables two separate networks to be created as required. Due to the two separate networks, a faster rate of data communication with extremely short response times is achieved. If your network has sufficient data transmission speed, one network may be sufficient for both types of data.

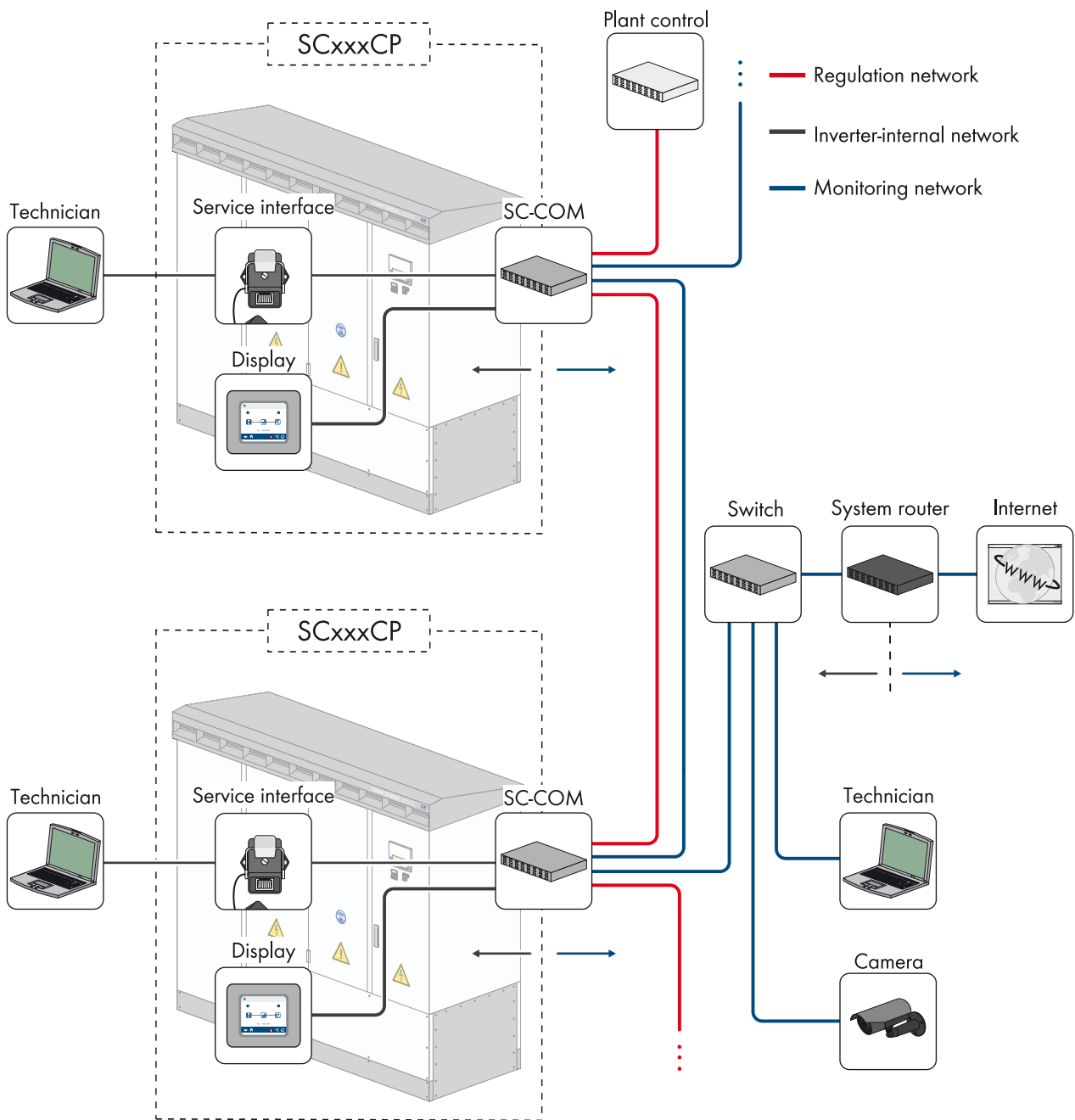

Figure 3: Basic principle of communication in large-scale PV power plants (example)

### Control Network LAN2

In the control network, the specifications of the network operator for grid management, such as target values for active and reactive power, are transmitted. The SC-COM transmits these specifications to the Sunny Central.

### Monitoring Network LAN3

In the monitoring network, the data for monitoring and parameterisation is transmitted. The parameters can be configured via an integrated web server and the user interface. The user interface also displays error messages and operating data.

## 3.3 LEDs of the SC-COM

### 3.3.1 LEDs on the Enclosure

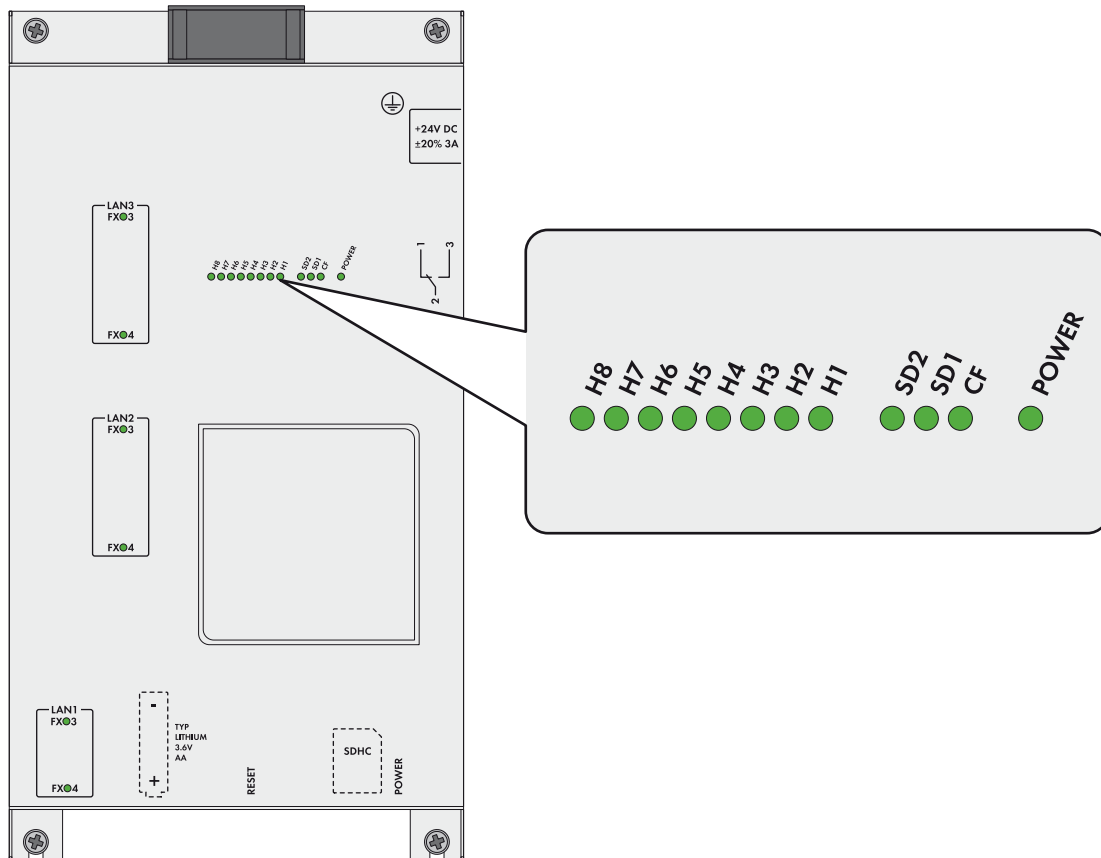

LED designation	Status	Explanation
POWER	Glowing green	The SC-COM is supplied with voltage.
	Off	The SC-COM is not supplied with voltage.
SD1	Flashing green	Read or write access to system drive
SD2	Flashing green	Read or write access to internal data drive
CF	Flashing green	Read or write access to external SD card memory
H1	Flashing green	The SC-COM is transmitting data to Sunny Portal/the FTP server.
	Glowing green	The most recent data transmission to Sunny Portal/the FTP server was successful.
	Glowing red	The most recent data transmission to Sunny Portal/the FTP server failed.
	Off	Data transmission to Sunny Portal/the FTP server is deactivated.

LED designation	Status	Explanation
H2	Flashing green	The SC-COM is communicating with the internally connected devices.
	Glowing green	Internal communication has taken place in the last five minutes.
	Glowing red	An error has occurred in the internal communication.
	Off	No internal communication has taken place in the last five minutes.
H3	Flashing red	The SC-COM is starting up.
	Glowing red	An error has occurred at the SC-COM.
	Glowing green	The SC-COM is ready for operation.
H4	Glowing green	An internal memory card exists and it is less than 92% full.
	Glowing red	The internal memory card is full and the oldest saved data is being overwritten.
	Flashing red	The internal memory card is 92% full.
H5	Glowing green	An external memory card exists and is less than 92% full.
	Glowing red	The external memory card is full.
	Flashing red	The external memory card is 92% full.
	Off	There is no external memory card.
H6	-	Not assigned
H7	-	Not assigned
H8	Flashing green	Application is running.

### 3.3.2 LEDs on the Network Terminal

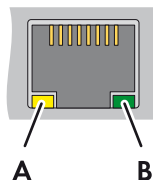

Figure 4: LEDs on the network terminal

Position	LED	Colour	Status	Explanation
A	Speed	Yellow	On	100 MBit data transfer rate
			Off	10 MBit data transfer rate
B	Link / Activity	Green	On	Connection (link) established
			Flashing	The SC-COM is currently transmitting or receiving data (activity).
			Off	No connection established

### 3.3.3 LEDs on the Optical Fibre Terminals

The SC-COM is also available with pre-wired optical fibre connections. If the optical fibres are connected to the splice box of the Sunny Central, the status of the connection will be indicated by the LEDs of the SC-COM.

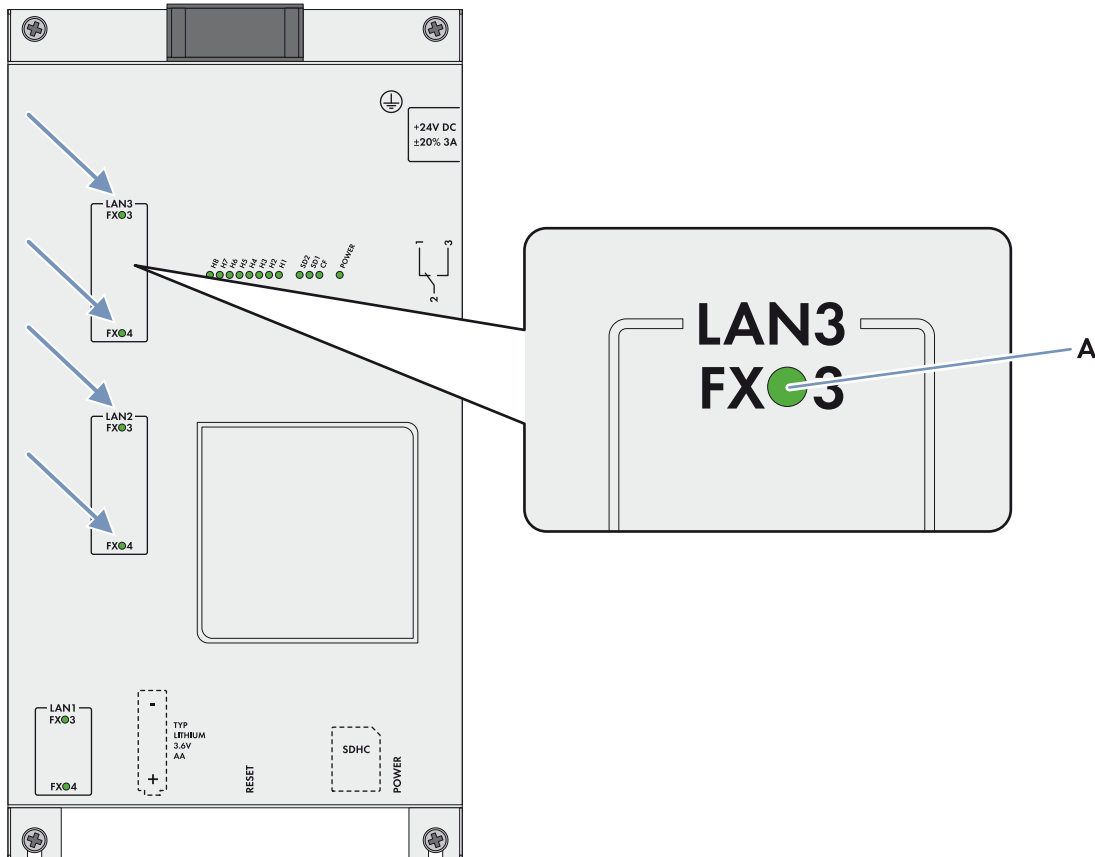

Figure 5: LEDs for the status of the optical fibre connection

Position	LED	Colour	Status	Explanation
A	Link / Activity	Green	On	Connection (link) established
			Flashing	The SC-COM is currently transmitting or receiving data (activity).
			Off	No connection established

## 3.4 User Interface

### 3.4.1 Design

Via the user interface, you can set the communication of your PV plant devices, configure the Sunny Central parameters and read off error messages and operating data.

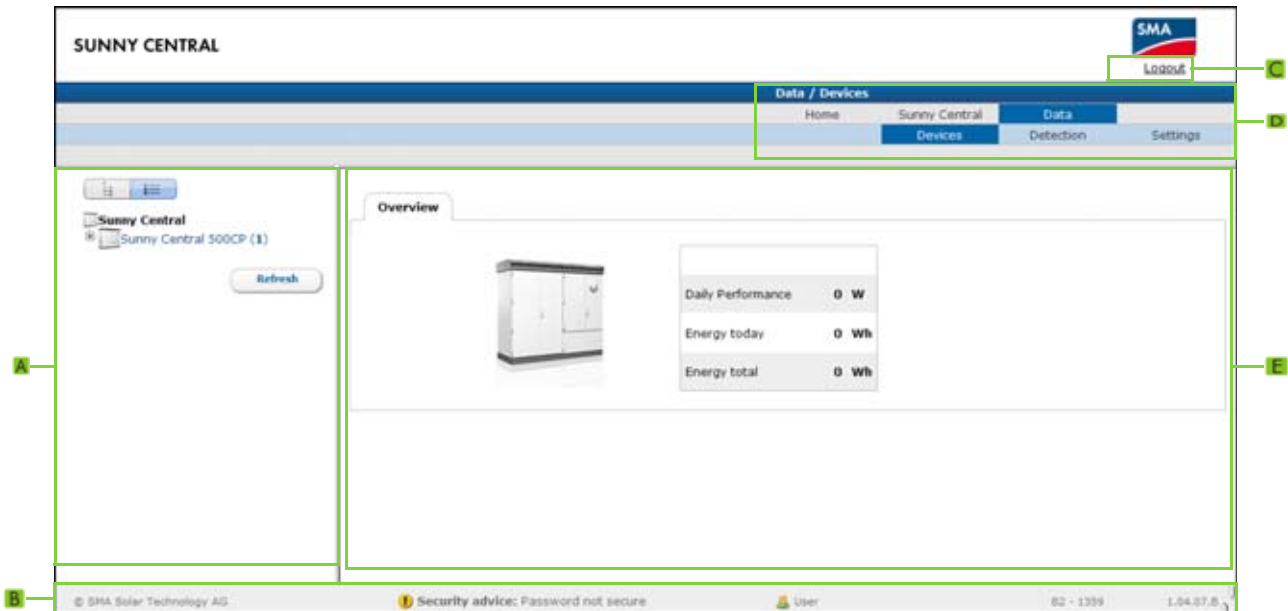

Figure 6: Design of the user interface (example)

Position	Designation
A	Structural view or device view
B	Status bar
C	Logout button
D	Navigation bar
E	Content area

### 3.4.2 Structural View and Device View

In the structural view and the device view, you can call up data of the individual devices of your PV plant. Depending on the view, the devices are sorted and displayed differently.

#### Structural View

In the structural view, the user interface shows the devices in the order in which they are connected to the data bus.





#### Device View

In the device view, the user interface shows all devices sorted by device type. Device types are, for example, all Sunny Centrals. The number shown in parentheses indicates the number of devices of a device type.



## Status Icons

Depending on the status of the device communication, the device icons are displayed in the structural or device view with various status icons.

Icon	Explanation
	The Sunny Central is ready for operation.
	An error has occurred in the Sunny Central.
	An error has occurred in the communication with the Sunny Central.

## 3.5 Type Label and Firmware Version

The type label provides a unique identification of the SC-COM. The type label can be found on the top of the enclosure. You will find the following information on the type label:

- Device type
- Serial number
- Registration ID
- MAC addresses of the LAN interfaces

The firmware version can be found in the user interface of the SC-COM. The current firmware version is displayed on the right-hand side of the status bar.

You will require the information on the type label to use the product safely and when seeking customer support from the SMA Service Line. The type label must be permanently attached to the product.

### Symbol on the Type Label

Symbol	Explanation
	Observe the documentation. Observe all documentation supplied with the product.

### Additional Label with Data

The type label contains a label with the serial number of the SC-COM, the registration ID and the MAC addresses of the LAN interface. You can pull off this label and attach it to your documents or to a place where you can quickly access the data.

## 4 Logging In and Out of the User Interface

### 4.1 Logging Into the User Interface

#### Default Network Settings of the SC-COM for the Service Interface on Delivery

IP address: 192.168.100.2

Subnet mask: 255.255.255.0

Password for the "installer" and "user" user groups: sma

#### Identical passwords for the user groups

If your "User" password is the same as your "Installer" password, you will automatically be logged in as an installer.

- Change the default passwords for the user groups after you log in for the first time (see Section 6.1 "Configuring Security Settings", page 21).

#### Requirement:

- JavaScript must be activated in the Internet browser (e.g. Internet Explorer).

#### Procedure:

1. Connect the laptop to the service interface of the Sunny Central.
2. Start Internet browser.
3. Enter the IP address of the SC-COM into the address bar and press the enter key.
  - The SC-COM login page opens.
  - The SC-COM login page does not open?
    - Rectify the fault (see Section 9 "Troubleshooting", page 37).
4. Select the desired language in the **Language** field.
5. Enter the password in the **Password** field.
6. Select the button [**Login**].

### 4.2 Logging Out of the User Interface

Always log out from the user interface when you have finished your work. Closing your Internet browser will not log you out. If you do not perform any action in the user interface for ten minutes, you are logged out automatically.

#### Procedure:

- Select [**Logout**].



## 5 Commissioning

### 5.1 Sequence for Commissioning

Procedure		See
1	Configuring the Network Settings on the Computer	Section 5.2
2	Setting the Language and Time	Section 5.3
3	Configuring the SC-COM for The Local Network	Section 5.4
4	Detecting Devices	Section 5.5
5	Parameterising the Devices	Section 5.6

### 5.2 Configuring the Network Settings on the Computer

Before you can commission the SC-COM for the first time, you need to configure the computer based on the network settings of the SC-COM.

#### **i** Administrator rights in the operating system

To commission the SC-COM, you need to have the appropriate administrator rights to change the computer's network settings.

- Contact your network administrator if you have any questions on administrator rights.

#### **Procedure:**

1. Note down the IP address of the computer.
2. Adapt the IP address of the computer to the address range of the SC-COM.

### 5.3 Setting the Language and Time

For correct display of reported events, you must set the language and time.

#### **Procedure:**

1. Log in on the user interface.
2. Set the language (see Section 6.2.2, page 22).
3. Set the time (see Section 6.2.1, page 22).

## 5.4 Configuring the SC-COM for the Local Network

### 5.4.1 Information on Integrating the SC-COM into a Local Network

#### Protecting the Ethernet network from external attacks

Secure your Ethernet network from external threats by means of appropriate safety measures such as a firewall and the allocation of secure passwords.

You can also change the network settings of the SC-COM using the XML file **custom.xml** (see Section 6.3 "Customer-Specific Settings via XML File", page 24).

### 5.4.2 Configuring the SC-COM for a Static Network

The SC-COM has three LAN interfaces for connected nodes.

Network	Factory-set IP address
LAN1: Service interface of the Sunny Central	192.168.100.2*
LAN2: Control network	172.24.1.51
LAN3: Monitoring network	172.16.1.51

\* This IP address cannot be changed.

#### Procedure:

1. Log in on the user interface.
2. Select **Sunny Central > Settings > Network**.
3. In the field **IP address**, enter the static IP address that you want to use to access the SC-COM in the local network.
4. Enter the subnet mask of your network in the field **Subnet mask**.
5. Enter the gateway IP address of your network in the field **Gateway address**. Usually, the IP address of the router has to be entered here.
6. Enter the IP address of the DNS server (Domain Name System) in the field **DNS server address**. Usually, the IP address of the router has to be entered here.
7. Select [**Save**] and [**Confirm**].

### 5.4.3 Configuring the SC-COM for Dynamic Networks

The SC-COM can obtain the network settings from a DHCP server. The IP address, subnet mask, gateway and DNS server are automatically obtained from the DHCP server when the SC-COM is started.

#### Using DHCP

Before setting the SC-COM to dynamic IP address assignment, check your DHCP server. The DHCP server must extend the lease of the assigned IP address. Do not use the DHCP server if it assigns a new IP address after the lease has expired. DHCP servers can normally list all devices to which you have assigned an IP address. You can then identify the SC-COM based on your MAC address. The MAC address of your SC-COM can be found on the type label or by selecting **Sunny Central > Info** on the user interface.

#### Procedure:

1. Log in on the user interface.
2. Select **Sunny Central > Settings > Network**.
3. Enable **DHCP** in the field **IP address**.
4. Select [**Save**].

## 5.4.4 Adjusting Network Ports

If you would like to make the SC-COM available on the Internet to allow, for example, direct access to the SC-COM via the Sunny Portal, you must configure a port redirection in your router. The network ports of the SC-COM may need to be adjusted.

The SC-COM uses four network ports for various services. If these ports are reserved for other applications in your network, you can change the ports.

### Adjusting the Network Ports

Make sure the SC-COM can access the web server before you change the **Public virtual HTTP port** setting on the device. In most cases, the settings do not have to be changed manually, as the router automatically forwards the queries to the correct ports via the network. Before adjusting the ports, contact your network administrator.

#### Requirement for setting of dynamic DNS:

- An account must be registered with a DynDNS provider and the login data must be available.

#### Procedure:

1. Log in on the user interface.
2. Select **Sunny Central > Settings > Network**.
3. In the field **Virtual public HTTP port**, enter the port enabled in the router for HTTP access. This port allows you to access the SC-COM web server via the Internet.
4. In the field **Webserver port**, enter the port via which the web server of the SC-COM can be reached.
5. In the field **Webservice port**, enter the port via which the SC-COM sends data to Sunny Portal and loads firmware updates.
6. If you would like to use the Modbus<sup>®\*</sup>, activate the box **Use Modbus**.

### Unauthorised access to the SC-COM

If you activate the Modbus protocol, unauthorised access to the SC-COM is possible. Even users without passwords will be able to view the operating data of supported devices or change the system time of the SC-COM.

7. In the field **Modbus port**, enter the port that you want the SC-COM to use when communicating via the Modbus protocol. The default setting is port 502.
8. If you would like to use a proxy server, activate the **Use proxy server** box.
9. Enter the IP address and the port of the proxy server in the field **Proxyserver address**.
10. If you would like to use the authentication of the proxy server, activate the box **Use authentication**.
11. Enter the data of your proxy server in the fields **User name** and **Password**.
12. If you wish to use a dynamic DNS, activate the box **Use Dyn.DNS**.
13. Select the provider in the the **Dyn. DNS provider** field.
14. Enter the required data in the fields **Domain name**, **User name**, **User password**.
15. Select the button **[Save]**.

---

\* Modbus<sup>®</sup> is a registered trademark of Schneider Electric and is licensed by the Modbus Organization, Inc.

## 5.5 Detecting Devices

During commissioning of a PV plant, all devices must be detected. If multiple interfaces (e.g. COM2 and COM3) are used in the inverter, detection must be carried out separately for all interfaces. Devices will need to be re-detected if you:

- Have exchanged devices in your PV plant
- Have removed devices from your PV plant
- Have added devices to your PV plant

### Detection of a PV plant may take several minutes

Depending on the number of devices in your PV plant, the detection process may vary in duration.

1. If the SC-COM does not indicate any progress after three minutes, cancel the search.
2. Make sure the data cable of each device is properly connected and repeat the search.

#### Procedure:

1. Log in on the user interface.
2. Select **Data > Detect**.
3. In the field **Total number of devices to be detected**, enter the number of devices connected to the SC-COM.
4. Select the button **[Start detection]**.
  - The SC-COM starts detecting all devices and displays its progress. As soon as all devices have been detected, the SC-COM reports "### Device detection finished###".
5. Select the button **[OK]**.

## 5.6 Parameterising the Devices

To change any parameters that affect device functionality, you must login as an installer. Contact your power supply company before changing any grid-relevant parameters (see the operating manual of the Sunny Central for information on the individual parameters).

#### Procedure:

1. Log into the user interface as an installer.
2. Select **Data > Devices**.
3. Select a device in the device view or structural view.
4. Select the **Parameters** tab.
5. Change the respective parameter via the **Value** field.
6. To adopt this value for all devices of the same type and with the same firmware version, activate the box **Save for all devices of this device type**. Note that, for Sunny SensorBox devices, the units of measure for ambient temperature, cell temperature and wind speed must also match.
7. Select the button **[Save]**.
  - The SC-COM now adjusts the required value on the device(s). Once the SC-COM has changed the value, the message "### Parameter change finished ###" appears.
8. Select the button **[OK]**.

## 5.7 Deleting Device Descriptions

Whenever you replace a device in your PV plant, the descriptions of the existing devices must be deleted so that the SC-COM can detect new devices.

#### Procedure:

1. Log into the user interface as an installer.
2. Select **Sunny Central > Info**.
3. Select **[Delete device descriptions]**.

## 6 Setting the SC-COM

### 6.1 Configuring Security Settings

#### 6.1.1 Changing the Password

To change the password for the "installer" user group, you must be logged in as an installer.

To change the password for the "user" user group, you can be logged in as a user or an installer.

##### **Identical passwords for the user groups**

If your "User" password is the same as your "Installer" password, you will automatically be logged in as an installer.

While you enter your password, the user interface displays information on the security level of the password entered. The SC-COM categorises passwords as **very unsafe**, **unsafe**, **adequate**, **safe** and **very safe**. Only select passwords with a security quality level that is at least **safe**.

You can also change the password of the "installer" user group via the XML file **custom.xml** (see Section 6.3 "Customer-Specific Settings via XML File", page 24).

##### **Procedure:**

1. Log in on the user interface.
2. Select **Sunny Central > Settings > Security**.
3. Enter a secure password in the **User password** or **Installer password** fields and confirm it in the second field.
4. Select the button [**Save**].

#### 6.1.2 Deactivating the RPC Interface

You can obtain all operating data from the SC-COM for external data processing systems using an RPC interface (for information on the RPC interface, see the Sunny WebBox RPC user manual). On delivery, the RPC interface is activated.

##### **Unauthorised access to the operating data**

If you activate the RPC interface, unauthorised access to the operating data is possible. Even users without passwords can view the operating data of supported devices.

- To prevent unauthorised access to the operating data, deactivate the RPC interface.

##### **Procedure:**

1. Log into the user interface as an installer.
2. Select **Sunny Central > Settings > Security**.
3. Select the option **Disabled** in the field **RPC interface**.
4. Select the button [**Save**].

## 6.2 Configuring System Settings

### 6.2.1 Setting the Date, Time and Time Zone

1. Log in on the user interface.
2. Select **Sunny Central > Settings > System**.
3. Select [**Change**] in the field **Time zone (UTC offset)**.
4. Select the correct time zone in the drop-down list **Time zone (UTC offset)**.
5. Select an option in the **Automatic change from summer time to winter time** field:

Option	Explanation
<b>yes</b>	Automatic change from summer time to winter time is active.
<b>no</b>	Automatic change from summer time to winter time is not active. Date and time have to be set manually.

6. Enter the current date in the **New date** field.
7. Enter the current time in the **New time** field.
8. Select the button [**Save**].

### 6.2.2 Setting the Language

You can also set the language of the user interface via the XML file **custom.xml** (see Section 6.3 "Customer-Specific Settings via XML File", page 24).

#### Procedure:

1. Log in on the user interface.
2. Select **Sunny Central > Settings > System**.
3. Select the desired language in the **Language** field.
4. Select the button [**Save**].

### 6.2.3 Entering the Operator Name

1. Log in on the user interface.
2. Select **Sunny Central > Settings > System**.
3. Enter the operator name in the **Operator name** field.
4. Select the button [**Save**].

### 6.2.4 Resetting the SC-COM

Resetting the SC-COM will restore all settings and parameters to their default settings. If you have uploaded the file **custom.xml**, the settings in this file take effect.

#### Data backup

- Before you reset the SC-COM, note down all settings such as network or portal settings.
- To avoid data loss, be sure to back up your PV plant data.

### **Plant identifier in Sunny Portal**

If you reset all the SC-COM settings, the SC-COM will delete all login settings for Sunny Portal. If you restart the SC-COM after reset without changing any settings, the SC-COM will create a new plant with a new plant identifier in Sunny Portal.

- If the SC-COM is configured to send data to the existing PV plant in Sunny Portal, adjust the identifier of the existing PV plant (see Section 7.3.2 "Adjusting the Plant Identifier for Sunny Portal", page 27).
- Enter the e-mail address of a user who has administrator rights for the plant in Sunny Portal.

#### **Procedure:**

1. Log into the user interface as an installer.
2. Select **Sunny Central > Info**.
3. Select [**Default setting**].
  - A window containing a security prompt opens.
4. Select the button [**Confirm**].

## **6.2.5 Restarting the SC-COM**

In the event of disturbances in communication with the devices connected to the Sunny Central, you can restart the SC-COM.

#### **Procedure:**

1. Log into the user interface as an installer.
2. Select **Sunny Central > Info**.
3. Select [**Stop system**].
  - A security prompt appears.
4. Select the button [**Confirm**].
  - The SC-COM is restarted.

## 6.3 Customer-Specific Settings via XML File

This section describes how to configure the system and network settings using an XML file, **custom.xml**. To enable the settings, the SC-COM must be reset to the default settings.

The settings using the XML file are optional. Most settings can also be configured via the user interface.

### 6.3.1 Uploading the custom.xml File

If you upload the **custom.xml** file to the user interface, the SC-COM checks the file to ensure that the values entered are valid, and copies the settings when the SC-COM is next reset. All settings and parameters which cannot be set using the XML file are reset to their default settings.

#### Correct network settings

While uploading, the SC-COM checks the XML file **custom.xml** for validity of the entered values. It is not checked whether the settings for the network are correct.

- Ensure that the **custom.xml** file contains the correct network settings.

#### Procedure:

1. Create the **custom.xml** file with the required settings (see Section 10.2 "XML File custom.xml", page 40).
2. Log into the user interface as an installer.
3. Select **Sunny Central > Settings > System**.
4. Select [**Browse**] in the **Upload settings (custom.xml)** field.
5. To select the **custom.xml** file in the open dialog box, double-click on it.
6. Select [**Upload**].
  - The SC-COM checks the file for validity and displays "Do you really want to apply the customer-specific settings?"
  - The SC-COM checks the file for validity and displays "The settings have not been activated because the file has an invalid format or invalid entries."
    - Click on the icon .
    - Read off the error in the open dialog box and correct the **custom.xml** file.
    - Ensure that the **custom.xml** file is valid and correct.
7. Select [**Confirm**].
  - The SC-COM displays "The settings have been saved successfully. The settings will become effective by carrying out a reset to default settings."
8. To enable the settings in the **custom.xml** file, reset the SC-COM to the default settings (see Section 6.1 "Configuring Security Settings", page 21).

### 6.3.2 Downloading the XML File custom.xml

The file **custom.xml** that you uploaded can also be downloaded.

#### Procedure:

1. Log into the user interface as an installer.
2. Select **Sunny Central > Settings > System**.
3. Click on the **custom.xml** link in the **Upload settings (custom.xml)** field.
4. Choose a storage location for the file and save it.



### 6.3.3 Deleting the custom.xml File

You can delete the **custom.xml** file via the user interface. If you have made your personal settings effective via the **custom.xml** file before deleting it, these settings remain effective. If necessary, save the file **custom.xml** before deleting it (see Section 6.3.2).

**Procedure:**

1. Log into the user interface as an installer.
  2. Select **Sunny Central > Settings > System**.
  3. In the field **Upload settings (custom.xml)**, select the **[Delete]** button.
- The **custom.xml** file is immediately deleted.

## 7 Managing Data

### 7.1 Setting the Averaging

The SC-COM can average the data over a defined time period. The data of the connected devices can be compressed and occupy less memory space in the SC-COM.

**Procedure:**

1. Log in on the user interface.
2. Select **Sunny Central > Recording**.
3. In the field **Averaging over**, select the time period for which the SC-COM is to calculate the average.
4. Select the button [**Save**].

### 7.2 Setting the Data Transmission Frequency

The SC-COM can transmit data to Sunny Portal or an external FTP server. You can specify how often and at what intervals data is to be sent by the SC-COM. All data upload settings apply to both data uploads to the Sunny Portal and data uploads to an external FTP server.

If the data transmission from the SC-COM to the Sunny Portal or external FTP server fails, the SC-COM will make further attempts to transmit the data.

**Procedure:**

1. Log in on the user interface.
2. Select **Sunny Central > Settings > Data transmission**.
3. Select the upload frequency and time window in the **Upload frequency per time window** field.
4. Select the maximum number of upload attempts in each time window in the field **Maximum number of upload attempts per time window**.
5. Select the button [**Save**].

## 7.3 Setting Data Communication with Sunny Portal

### 7.3.1 Registering the SC-COM in Sunny Portal

1. Log in on the user interface.
2. Select **Sunny Central > Settings > Data transmission**.
3. Enter the name of your plant in the field **Plant name**. The name you enter will be displayed as the plant name in Sunny Portal.
4. Setting the Data Transmission Frequency (see Section 7.2 "Setting the Data Transmission Frequency", page 26).
5. Select **yes** in the **Use Sunny Portal** field.

6.  **Automatic plant identifier**

In general, you do not have to change the preset number in the **Plant identifier** field. Sunny Portal uses this number to uniquely identify your PV plant. If you have not yet registered the plant in Sunny Portal, the SC-COM will automatically enter the preset plant identifier in Sunny Portal after the first successful data upload.

Sunny Portal will send the login data to the e-mail address you entered in the **Operator e-mail** field. The plant is now registered in Sunny Portal.

- If the plant is already registered in Sunny Portal, update the plant identifier in the field **Plant identifier** (see Section 7.3.2 "Adjusting the Plant Identifier for Sunny Portal", page 27).

7. Enter your e-mail address in the **Operator e-mail** field. Sunny Portal sends your access data to this e-mail address.
8. Select the button [**Save**].
9. Select **Sunny Central > Info**.
10. Select [**Register**] in the field **Last Sunny Portal registration**. The Sunny Portal password will be sent to the specified e-mail address.

### 7.3.2 Adjusting the Plant Identifier for Sunny Portal

Sunny Portal identifies your SC-COM via the plant identifier. In the following cases, you must adjust the plant identifier in the SC-COM:

- Plant data has already been sent to Sunny Portal via another communication device.
- The plant identifier assigned to the SC-COM was reset.
- The SC-COM was replaced by a different SC-COM.

**Procedure:**

1. Log into Sunny Portal ([www.SunnyPortal.com](http://www.SunnyPortal.com)).
2. Select **Configuration > Plant Properties**.
3. Copy the plant identifier to the clipboard.
4. Log in on the user interface.
5. Select **Sunny Central > Settings > Data transmission**.
6. Delete the content of the **Plant identifier** field.
7. Paste the plant identifier from the clipboard into the **Plant identifier** field.
8. Select the button [**Save**].

### 7.3.3 Deleting the Sunny Portal Buffer

You can delete the data on the internal ring buffer.

1. Log into the user interface as an installer.
2. Select **Sunny Central > Info**.
3. Select [**Delete**] in the "**Sunny Portal Buffer Load**" field.

## 7.4 Setting Data Communication with the FTP Server

### 7.4.1 Defining Read and Write Access Rights for the FTP Server

The SC-COM is equipped with an integrated FTP server. You can use the FTP server to access the data on the SC-COM. You can call up the data in CSV or XML format and download it (see Section 7.4.3 "Setting and Testing the FTP Push Function", page 29). In order to use the FTP server, you must first assign the respective read and write access rights for the FTP server on the SC-COM.

**Procedure:**

1. Log in on the user interface.
2. Select **Sunny Central > Settings > Security**.
3. Select an option in the field **FTP server**:

Option	Explanation
<b>Read/write</b>	You have read and write access rights on the integrated FTP server.
<b>Read only</b>	You only have read access rights on the integrated FTP server.
<b>Off</b>	The integrated FTP server is deactivated.

4. Select the button [**Save**].

### 7.4.2 Calling up the FTP Server via the Internet Browser

You can log into the FTP server of the SC-COM as either "user" or "installer".

**i** **Stored user name and password in the Internet browser**

After you have accessed the FTP server of the SC-COM with an Internet browser, the user name and passwords remain saved in the Internet browser cache.

- Clear the Internet browser cache to prevent unauthorised access to the FTP server of the SC-COM.

**Procedure:**

1. Start Internet browser.
2. Enter the FTP address of the SC-COM with your user name and password as: ftp://[user name]:[password]@[IP address]

**Example: Entering the FTP address**

If you want to log into the SC-COM with IP address 192.168.100.2 and your user name is "user" and password is "1234", the correct FTP address is ftp://user:1234@192.168.100.2

3. Press the enter key.

### 7.4.3 Setting and Testing the FTP Push Function

The SC-COM is equipped with an FTP push function. With this function, the data collected from your PV plant can be uploaded as an XML file to a local FTP server (for information on installing a local FTP server and testing the FTP push function, see the technical information "Setting Up a Local FTP Server" at [www.SMA.de](http://www.SMA.de)).

#### Procedure:

1. Log in on the user interface.
2. Select **Sunny Central > Settings > Data transmission**.
3. Select yes in the field **Use FTP-Push service**.
4. Enter the URL and port of the FTP server in the field **FTP server**.
5. In the field **Upload directory**, specify the desired folder on the FTP server in which the data is to be saved.
6. Select an option in the field **Use authentication**:

Option	Explanation
<b>yes</b>	Authentication is required for the FTP server. Continue with step 7.
<b>no</b>	Authentication is not required. Continue with step 8.

7. Enter the data of your FTP server in the fields **User name** and **Password**.
8. Set the data transmission frequency (see Section 7.2, page 26).
9. To test the FTP push function, select the **[testing]** button in the field **Test FTP connection**.
  - The test file is sent to the FTP server.
  - The test file is not sent to the FTP server?
    - Ensure that the address of the FTP server and the upload directory are correct.
    - Repeat the FTP connection test.
    - If errors occur, contact your network administrator.
10. Select the button **[Save]**.

## 7.5 Making Settings for Modbus Communication

### 7.5.1 Managing Modbus Profiles

Using a Modbus profile, a Modbus master can access the data of a Modbus slave, for example, from a SCADA system to the data of the SC-COM (for information on the Modbus interface and the Modbus profiles, see the technical description "Sunny WebBox / SC-COM Modbus Interface" at [www.SMA-Solar.com](http://www.SMA-Solar.com)).

#### Procedure:

1. Log in on the user interface.
2. Select **Data > Devices > Modbus**.
3. To upload a Modbus profile or a Modbus master profile, carry out the following steps:
  - In the field **Upload profile**, upload the file **virtualmodbus.xml** or **modbusmaster.xml**.
  - Select the button [**Upload**].
  - Select the button [**Confirm**]. In the field **Virtual Modbus profile**, you can now select the buttons [**Download**] and [**Delete**].
4. To download the relevant profile, select [**Download**].
5. To delete the relevant profile, select [**Delete**].

### 7.5.2 Changing the Unit ID

With the Modbus protocol, devices can be addressed via the unit ID (for information on the Modbus protocol and Modbus profiles, see the Technical Description "Sunny WebBox / SC-COM Modbus Interface"). After the devices have been detected, you can change the unit IDs of the devices and the uploaded Modbus profiles on the user interface.

#### Requirement:

- All devices that are connected to the Sunny Central must be detected (see Section 5.5, page 20).
- If necessary, a Modbus profile must be uploaded.

#### Procedure:

1. Log in on the user interface.
2. Select **Data > Devices > Modbus**.
3. Enter the required Unit ID in the column **Unit ID** next to the respective device or profile.
4. Select the button [**Save**].

## 7.6 Downloading Data via HTTP

### 7.6.1 Downloading Data in XML Format

You can download the data collected by the SC-COM via HTTP download. This function makes it possible to manually download your collected plant data in CSV or XML format to your computer.

**Requirement:**

- Averaging must be activated (see Section 7.1, page 26).

**Procedure:**

1. Log in on the user interface.
2. Select **Sunny Central > Recording**.
3. Select **XML** in the **Format** field.
4. Select the required month in the field **Download**. The data for the previous twelve months is available for download via the user interface.
5. Select [**Download**].
6. Choose the save location.
7. Select the button [**Save**].

### 7.6.2 Downloading Data in CSV Format

Data saved in CSV format can be automatically imported into tables (e.g. in Microsoft Excel). The data is structured based on the separator and end-of-line characters that you specify.

**Requirement:**

- Averaging must be activated (see Section 7.1, page 26).

**Procedure:**

1. Log in on the user interface.
2. Select **Sunny Central > Recording**.
3. Select the option CSV in the field **Format**.
4. Select [**Configure**].
5. Select the desired format of the file name in the field **Filename format**.
6. Select an option in the field **Create column headers**:

Option	Explanation
<b>yes</b>	A header is added to the CSV file.
<b>no</b>	A header is not added to the CSV file.

7. Select an option in the field **End-of-line character**:

Option	Explanation
<b>CRLF (Windows)</b>	Control character for Windows that is used to separate lines in a CSV file.
<b>LF (Unix/Linux)</b>	Control character for Unix/Linux that is used to separate lines in a CSV file.
<b>CR (Mac)</b>	Control character for Macintosh that is used to separate lines in a CSV file.

8. In the field **Separator character**, select the character you want to use to separate content in the CSV file.  
Tip: If you want to import CSV data into Microsoft Excel for evaluation, choose **Comma** as the separator.

9. In the field **Number format**, select the desired number format. Tip: If you want to import CSV data into Microsoft Excel for evaluation, select **###** as the number format.
10. In the field **Timestamp format**, select the desired time format.
11. Select an option in the field **Format of the status channels**:

Option	Explanation
<b>Numeric</b>	Status information on the Sunny Central is displayed in numeric format.
<b>Plain text</b>	Status information on the Sunny Central is displayed as text.

12. Select the button [**Save**].
13. Select the required month in the field **Download**. The data for the previous twelve months is available for download via the user interface.
14. Select [**Download**].
15. Select the button [**Save**].
16. Choose the save location.
17. Select the button [**Save**].



## 7.7 Storing Data on the Memory Card

### 7.7.1 Information on Saving Data on a Memory Card

You can save all the data collected from the Sunny Central to a memory card. The save-to-memory-card feature is disabled by default on delivery.

If a memory card is inserted into the slot of the SC-COM and saving data to external storage media is enabled, the SC-COM will copy all data from the internal ring buffer to the external SD card. The SC-COM stores new data on the memory card for as long as the memory card is inserted in the slot.

The SC-COM creates a folder on the memory card. The name of the folder is "SC-COM\_[SerialNumber]". "[SerialNumber]" designates the serial number of the respective SC-COM. The SC-COM creates a new subfolder in the main folder every day. Each subfolder contains all the data collected by the SC-COM. When the memory card has reached its capacity, the **H5** LED lights up red and the SC-COM stores no further data on the memory card. Replace the memory card or reformat it on the computer. You can also read on the user interface, how full the memory card is (see Section 7.8 "Determining Available Memory Space", page 34).

#### **i** Data loss when removing the memory card

Do not remove the memory card while the SC-COM is storing data on the memory card. This can damage the file system of the memory card and lead to data loss. Depending on the amount of data, the writing process can take some time.

### 7.7.2 Inserting the Memory Card

#### 1. **⚠ DANGER**

**Danger to life due to electric shock by touching live components of the Sunny Central**

- After disconnecting the Sunny Central from voltage sources, wait until the Sunny Central capacitors discharge (see Sunny Central installation manual).

#### 2. Insert the memory card into the SC-COM slot.

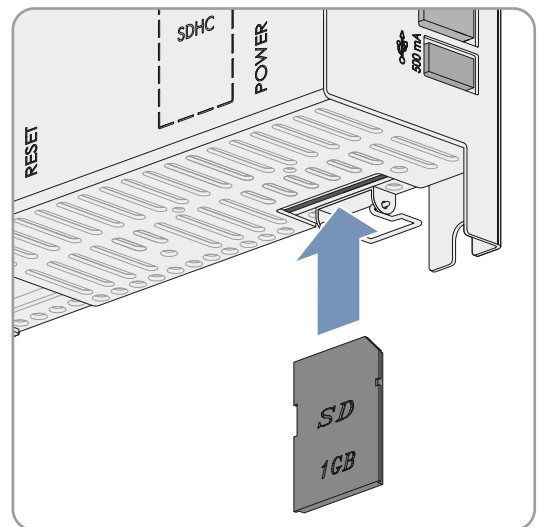

### 7.7.3 Enabling and Disabling Data Storage on the Memory Card

1. Log in on the user interface.
2. Select **Sunny Central > Settings > Security**.
3. To enable saving of the data to the memory card, select **Enabled** in the field **External memory**.
4. To deactivate saving of the data on the memory card, select **Disabled**.
5. Select the button **[Save]**.

## 7.8 Determining Available Memory Space

1. Log in on the user interface.
2. Select **Sunny Central > Info**.
3. The field **Sunny Portal buffer load** shows the available memory capacity in the internal ring buffer.
4. The field **SD card memory capacity** shows the available memory capacity on the memory card.

## 7.9 Displaying and Downloading the Event Report

The event report keeps a log of various SC-COM events, e.g. errors and warnings. You can also display the Sunny Central events in the event report. All events can be downloaded in a CSV file. .

On delivery, the automatic transmission of Sunny Central events to the SC-COM is disabled.

### Procedure:

1. Log in on the user interface.
2. To have the Sunny Central events always displayed in the event report, carry out the following steps:
  - Select **Sunny Central > Recording**.
  - In the field **Collect automatically fault logs**, select **yes**.
  - Select the button **[Save]**.
3. To have the Sunny Central events displayed once in the event report, carry out the following steps:
  - Select **Sunny Central > Recording**.
  - In the field **Manually requesting fault memory**, select **[Request]**.
  - The error messages from the Sunny Central are transmitted to the SC-COM.
  - In the field **Manually requesting event memory**, select **[Request]**.
  - All events from the Sunny Central are transmitted to the SC-COM.
4. Select **Sunny Central > Events**.
5. To download the events as a CSV file, select **[Download]**.
6. Choose the save location.
7. Select the button **[Save]**.

## 7.10 Activating Alert in the Event of a Fault

You can be informed by e-mail about events that occur. This allows you to react rapidly to failures in the PV plant and minimise downtime. On delivery, the alert is disabled.

### **i** SC-COM reports event of type error after two intervals of averaging

The SC-COM reports error type events, which persist twice as long as the time set for averaging (see Section 7.1 "Setting the Averaging", page 26).

Example: If the averaging setting is 15 minutes, the SC-COM reports an error if the fault exists for longer than 30 minutes.

#### Procedure:

1. Log in on the user interface.
2. Select **Sunny Central > Settings > Data transmission**.
3. In the field **Notification active**, select **yes**.
4. Select an option in the field **Multiple Notices (24h/48h)**:

Option	Explanation
<b>yes</b>	You immediately receive an e-mail if an event occurs. If the event persists after 24 hours and after 48 hours, the e-mail is sent again.
<b>no</b>	You receive an e-mail once if an event occurs. The e-mail with the error type events is sent after two intervals of averaging.

5. In the field **E-mail address**, enter the e-mail address. If an e-mail is to be sent to multiple e-mail addresses, separate the e-mail addresses with commas.
6. In the field **E-mail when**, select the desired event type when the e-mail is to be sent.
7. Enter the required data in the fields **Mail Server (SMTP)**, **Sender e-mail**, **User name**, and **Password**.
8. Select the button **[testing]**.
  - A test e-mail is sent to the specified e-mail address.
  - A test e-mail has not been received?
    - Check if the test e-mail is in the spam folder.
    - Make sure that the network settings of the SC-COM are correct.
    - Make sure the settings of the e-mail server are correct.
9. Select the button **[Save]**.

## 8 Updating the Firmware

### 8.1 Information on Updating the Firmware

You have the option of updating the firmware of the SC-COM automatically via the user interface. When the SC-COM firmware is updated, all the settings and data will be saved.

#### **No access to the user interface**

During the update, the SC-COM restarts and access to the user interface will be temporarily blocked.

### 8.2 Enabling Automatic Firmware Updates

If the SC-COM has Sunny Portal access, you can have the firmware updated automatically. The SC-COM checks whether a new firmware version is available every time data is transmitted to Sunny Portal. If a firmware update is available, the SC-COM will download the firmware update from the Internet and install it between 1:00 a.m. and 4:00 a.m. The automatic firmware update function is disabled on delivery.

#### **Requirement:**

- Communication with the Sunny Portal must be set (see Section 7.3, page 27).

#### **Procedure:**

1. Log in on the user interface.
2. Select **Sunny Central > Settings > Data transmission**.
3. Select the **Yes** option in the **Automatic firmware update** field.
4. Select the button [**Save**].

### 8.3 Updating the Firmware via the User Interface

1. Log in on the user interface.
2. Select **Sunny Central > Info**.
3. Select [**Refresh**] in the field **Version Firmware**.

## 9 Troubleshooting

### 9.1 Error Overview

Problem	Cause and corrective measures
<p>The user interface cannot be reached.</p>	<p>The network connection of the SC-COM has been interrupted.</p> <p><b>Corrective measures:</b></p> <ul style="list-style-type: none"> <li>• Make sure all network cables of the SC-COM and the computer are connected properly.</li> </ul> <hr/> <p>The network settings of the computer do not match the network settings of the SC-COM.</p> <p><b>Corrective measures:</b></p> <ul style="list-style-type: none"> <li>• Make sure the router settings are correct.</li> <li>• Make sure the Internet browser settings are correct. Define a proxy server exception if necessary.</li> <li>• Contact your network administrator if you require assistance.</li> </ul>
<p>SC-COM does not detect devices that are connected to the RS485 communication bus.</p>	<p>The data transmission protocol and the baud rate are not configured properly.</p> <p><b>Corrective measures:</b></p> <ul style="list-style-type: none"> <li>• Make sure the data transmission protocol and the baud rate for the connected devices are configured properly.</li> <li>• Make sure the RS485 cable is connected properly (refer to the RS485 cabling plan at <a href="http://www.SMA.de">www.SMA.de</a> for information on how the cables should be connected to the RS485 communication bus).</li> </ul>
<p>SC-COM does not transmit any data to Sunny Portal.</p>	<p>Data transmission is disabled.</p> <p><b>Corrective measures:</b></p> <ul style="list-style-type: none"> <li>• Enable data transmission to the Sunny Portal (see Section 7.3.1 "Registering the SC-COM in Sunny Portal", page 27).</li> <li>• Make sure the plant name and e-mail address you entered are correct. You may need to register again in the Sunny Portal.</li> </ul>
<p>After an FTP download, the Internet Explorer shows old SC-COM data.</p>	<p>The cache behaviour of the Internet Explorer means that an outdated version of the data is loaded from the SC-COM.</p> <p><b>Corrective measures:</b></p> <ul style="list-style-type: none"> <li>• Use an FTP client such as FileZilla to load data from the internal FTP server of the SC-COM.</li> </ul>
<p>The events in the event report do not appear in the expected location under "Time".</p>	<p>The time settings of the SC-COM and the connected device do not match.</p> <p><b>Corrective measures:</b></p> <p>Synchronise the time settings of the SC-COM and the connected device (see the manual of the connected device).</p>

Problem	Cause and corrective measures
<b>After an SC-COM is replaced, Sunny Portal contains two plants with the same name.</b>	<p>The replacement device logs into Sunny Portal with a new plant ID. Sunny Portal creates a new plant for this plant identifier, even if you gave the plant the same name.</p> <p><b>Corrective measures:</b></p> <ol style="list-style-type: none"> <li>1. Assign the plant identifier of the old plant to the replacement device (see Section 7.3.2 "Adjusting the Plant Identifier for Sunny Portal", page 27).</li> <li>2. In the replacement device, enter the e-mail address of a user who has administrator rights for the plant in Sunny Portal.</li> <li>3. In Sunny Portal, delete the new plant created by the replacement device.</li> </ol>
<b>SC-COM does not recognise the inserted memory card.</b>	<p>External storage is disabled in the SC-COM settings.</p> <p><b>Corrective measures:</b></p> <ul style="list-style-type: none"> <li>• Enable external storage in the SC-COM settings (see Section 7.7 "Storing Data on the Memory Card", page 33).</li> </ul>
<b>SC-COM does not transmit data via FTP push. H1 LED glows red.</b>	<p>The SC-COM FTP push function is not set correctly.</p> <p><b>Corrective measures:</b></p> <ul style="list-style-type: none"> <li>• Set the FTP push function correctly (see Section 7.4.3 "Setting and Testing the FTP Push Function", page 29).</li> </ul> <hr/> <p>You are not connected to the Internet.</p> <p><b>Corrective measures:</b></p> <ul style="list-style-type: none"> <li>• Restore the Internet connection.</li> <li>• If necessary, contact your Internet service provider.</li> </ul> <hr/> <p>The SC-COM FTP push function is not set correctly.</p> <p><b>Corrective measures:</b></p> <ul style="list-style-type: none"> <li>• Check that the server address, the user name and the password are set correctly in the FTP push settings (see Section 7.4.3 "Setting and Testing the FTP Push Function", page 29).</li> <li>• Check whether the user has write authorisation to the upload directory of the FTP server (see Section 7.4.1 "Defining Read and Write Access Rights for the FTP Server", page 28).</li> <li>• Ensure the server port is set to the correct value (see Section 7.4.3 "Setting and Testing the FTP Push Function", page 29).</li> <li>• Test the FTP push function of the SC-COM (see Section 7.4.3 "Setting and Testing the FTP Push Function", page 29).</li> </ul>

## 9.2 Sending ZIP File with Service Information

In order to help you quickly and effectively, the SMA Service Line may require a ZIP file containing service information. This ZIP file can be downloaded from the user interface. The files in the ZIP folder are protected with a service password. Only the SMA Service Line employees can access the files.

### Procedure:

1. Log in on the user interface.
2. Select **Sunny Central > Info**.
3. Create [**Create Service info**].
  - A dialog box for downloading the ZIP file is opened.
4. Save the ZIP file on the computer.
5. Send the ZIP file to the SMA Service Line.

## 10 Appendix

### 10.1 User Groups

The SC-COM distinguishes between the "user" and "installer" user groups. The distinction is made via different passwords. If the password is the same for both user groups, you will be logged in automatically as installer.

To prevent two users from making changes at the same time, only one user can ever be logged into the SC-COM at a time.

User group	Authorisation
User	<ul style="list-style-type: none"> <li>• Configure the system settings of the SC-COM, such as date and time</li> <li>• Configure the SC-COM for the network except for the network port setting</li> <li>• Read out the operating data and parameter settings</li> <li>• Change the password for the "user" user group</li> <li>• Download and manage the operating data</li> </ul>
Installer	<ul style="list-style-type: none"> <li>• All rights of the "user" user group</li> <li>• Adjust the network settings including those of the network ports</li> <li>• Set the inverter parameters</li> <li>• Restore the default settings of the SC-COM</li> <li>• Delete the device description</li> <li>• Delete the Sunny Portal buffer</li> <li>• Change passwords for both user groups</li> <li>• Adjust settings using the XML file</li> <li>• Enable Modbus option, upload Modbus profiles, and set unit IDs</li> <li>• Enable and disable the RPC interface</li> </ul>

### 10.2 XML File custom.xml

#### 10.2.1 Structure of the XML File custom.xml

You can upload your own system and network settings via the XML file **custom.xml**. The SC-COM checks the file for validity and accuracy of the entered values and takes over the settings when you reset the SC-COM.

Element of the XML file	Explanation
<?xml version="1.0" encoding="utf-8" standalone="yes" ?>	Required element of the XML file
<WebBox xmlns:msdata="urn:schemas-microsoft-com:xml-msdata" xmlns:xsi="http://www.w3.org/2001/ XMLSchema-instance" xsi:noNamespaceSchemaLocation="config_100.xsd">	Required element of the XML file Is finished with the tag </WebBox> at the end of the XML file
<Info> <Version> <b>my config V1.01</b> </Version> </Info>	Required element of the XML file. You have to enter the name and the version for your settings between the version tags. This information is displayed in the header of the user interface.



Element of the XML file	Explanation
<pre>&lt;Config&gt;   &lt;Key&gt;NetworkSettings_DhcpUsage1&lt;/Key&gt;   &lt;Value&gt;False&lt;/Value&gt; &lt;/Config&gt;</pre>	Here, you can set the parameters and your values (see Section 10.2.2 "Parameters and Values for the custom.xml File", page 41).
<pre>&lt;Loader&gt;   &lt;Settings&gt;     &lt;PowerFail&gt;2500&lt;/PowerFail&gt;   &lt;/Settings&gt; &lt;/Loader&gt;</pre>	<p>You can set the period in ms that determines the shut-down time of the SC-COM after the SC-COM has received the signal of the Sunny Central's uninterruptible power supply about the failure of the voltage supply.</p> <p>The value must be larger than or equal to 2,500. This setting is immediately adopted after the file is uploaded.</p>

### Example: XML file for setting the Czech language for the user interface

```
<?xml version="1.0" encoding="utf-8" standalone="yes" ?>
<WebBox xmlns:msdata="urn:schemas-microsoft-com:xml-msdata" xmlns:xsi="http://www.w3.org/2001/
XMLSchema-instance" xsi:noNamespaceSchemaLocation="config_100.xsd">
<Info>
  <Version>my config V1.01</Version>
</Info>
<Config>
  <Key>NativeSettings_Language</Key>
  <Value>cs</Value>
</Config>
</WebBox>
```

## 10.2.2 Parameters and Values for the custom.xml File

Parameters	Explanation	Values	Default values
NetworkSettings_DhcpUsage1	Activates the DHCP for LAN2. The <b>True</b> value ignores all other settings of the IP addresses for LAN2.	True False	False
NetworkSettings_Dns1pAddr1	Sets the first IPv4 address of the DNS server for LAN2	- 0.0.0.0 A valid IPv4 address	-
NetworkSettings_Dns2IpAddr1	Sets the second IPv4 address of the DNS server for LAN2	- 0.0.0.0 A valid IPv4 address	0.0.0.0
NetworkSettings_Gateway1	Sets the gateway address for LAN2	0.0.0.0	0.0.0.0
NetworkSettings_IpAddr1	Sets the IPv4 address for LAN2	A valid IPv4 address	172.24.1.51
NetworkSettings_SubnetMask1	Sets the subnet mask for the LAN2	255.255.0.0	255.255.0.0

Parameters	Explanation	Values	Default values
NetworkSettings_DhcpUsage2	Activates the DHCP for LAN3. The <b>True</b> value ignores all other settings of the IP addresses for LAN3.	True False	False
NetworkSettings_DnsIpAddr2	Sets the first IPv4 address of the DNS server for LAN3	- 0.0.0.0 A valid IPv4 address	-
NetworkSettings_Dns2IpAddr2	Sets the second IPv4 address of the DNS server for LAN3	- 0.0.0.0 A valid IPv4 address	0.0.0.0
NetworkSettings_Gateway2	Sets the gateway address for LAN3	0.0.0.0	0.0.0.0
NetworkSettings_IpAddr2	Sets the IPv4 address for LAN3	A valid IPv4 address	172.16.1.51
NetworkSettings_SubnetMask2	Sets the subnet mask for the LAN3	255.255.0.0	255.255.0.0
NetworkSettings_ModbusPort	Sets the Modbus port The following ports must not be used: 21 / 23 / 8081 / 30100	-	502
NetworkSettings_ModbusUsage	Activates the use of the Modbus protocol	True False	True
NetworkSettings_WebserverPort	Sets the port of the web server The following ports must not be used: 21 / 23 / 502 / 8081 / 30100	-	80
NativeSettings_Language	Sets the language of the user interface:	en cs de el es fr it ko nl pt	en
Security_InstallerPassword	Sets the installer password	-	sma

## 10.3 Plant Presentation in Sunny Portal

With the SC-COM, you can view data from your Sunny Central in Sunny Portal. The Sunny Portal monitors the PV plant and displays the yield and power output. In addition, Sunny Portal can send useful reports via e-mail.

If the SC-COM is unable to connect to Sunny Portal, it will store the collected plant data in an internal ring buffer. If the ring buffer is full, the SC-COM will overwrite the oldest data first. The SC-COM will send the data to Sunny Portal with the next data upload. The time the ring buffer can bridge depends on the device type and number of the detected devices.

On the **Sunny Central > Info** page, you can see when the SC-COM last successfully transmitted data.

Evaluating the collected data takes time. Please note that it can take several minutes for Sunny Portal to display the data of your PV plant.

## 10.4 Accessing the SC-COM via Sunny Portal

Using Sunny Portal, you can access the SC-COM via the Internet.

Every time the SC-COM connects with Sunny Portal, Sunny Portal saves the current address of the SC-COM or your router with which the Internet connection is established. If your router is configured accordingly, you can access your SC-COM via Sunny Portal.

The last IP address that the SC-COM used to connect to Sunny Portal will be updated by the SC-COM during each data transmission. You can view this IP address in Sunny Portal by selecting **Device Overview > Device Properties**.

If your network is permanently connected to the Internet, your Internet provider may disconnect the connection at regular intervals. This usually happens every 24 hours. When you establish a new Internet connection, your Internet provider will assign a new IP address to your network. The SC-COM will use the new IP address to connect to Sunny Portal. The IP address displayed by SC-COM is always up-to-date.

### **i** Accessing the SC-COM via Sunny Portal after a change of IP address

When your Internet provider assigns a new IP address to your network, Sunny Portal will not be able to access the SC-COM immediately. Before it can be accessed, the SC-COM must first send its new IP address to Sunny Portal. The SC-COM transmits the IP address of the network every time data is transmitted.

### **i** Router must forward data requests to the SC-COM.

To access the SC-COM via the Sunny Portal, your router must be configured to forward all data requests from Sunny Portal to the SC-COM.

- If you are unable to access the SC-COM, make sure the router settings are correct.

## 11 Technical Data

### Mechanical Data

Width x height x depth	386 mm x 201 mm x 60 mm
------------------------	-------------------------

Weight	2,820 g
--------	---------

### Voltage Supply

Typical power consumption	20 W
---------------------------	------

Maximum power consumption	28 W
---------------------------	------

### Ambient Conditions

Ambient temperature	-40 °C to +70 °C
---------------------	------------------

Relative humidity	5% to 95%, non-condensing
-------------------	---------------------------

Degree of protection *	IP30
------------------------	------

\* Degree of protection according to DIN 60529

### Communication

Sunny Central	RS485, 10/100 Mbit Ethernet
---------------	-----------------------------

Computer	10/100 Mbit Ethernet
----------	----------------------

RS485 radio range	1,200 m
-------------------	---------

Ethernet radio range	100 m
----------------------	-------

### Other

Memory expansion through memory card	Up to 32 GB
--------------------------------------	-------------

## 12 Contact

If you have technical problems concerning our products, please contact the SMA Service Line. We require the following data in order to provide you with the necessary assistance:

- Operating system of your computer
- Firmware version of the SC-COM
- Serial number and hardware version of the SC-COM
- Version of the printed circuit board of the SC-COM
- Type and serial numbers of the Sunny Central connected to your PV plant
- ZIP file with service information (see Section 9.2, page 39)

Australia	SMA Australia Pty Ltd. Sydney	Toll free for Australia:	1800 SMA AUS (1800 762 287)
		International:	+61 2 9491 4200
Belgien/ Belgique/ België	SMA Benelux BVBA/SPRL Mechelen	+32 15 286 730	
Brasil	Vide España (Espanha)		
Česko	SMA Central & Eastern Europe s.r.o. Praha	+420 235 010 417	
Chile	Ver España		
Danmark	Se Deutschland (Tyskland)		
Deutschland	SMA Solar Technology AG Niestetal	Medium Power Solutions Wechselrichter: Kommunikation: SMS mit „Rückruf“:	+49 561 9522-1499 +49 561 9522-2499 +49 176 888 222 44
		Hybrid Energy Solutions Sunny Island:	+49 561 9522-399
		Power Plant Solutions Sunny Central:	+49 561 9522-299
España	SMA Ibérica Tecnología Solar, S.L.U. Barcelona	Llamada gratuita en España: Internacional:	900 14 22 22 +34 902 14 24 24
France	SMA France S.A.S. Lyon	Medium Power Solutions Onduleurs : Communication :	+33 472 09 04 40 +33 472 09 04 41
		Hybrid Energy Solutions Sunny Island :	+33 472 09 04 42
		Power Plant Solutions Sunny Central :	+33 472 09 04 43
India	SMA Solar India Pvt. Ltd. Mumbai	+91 22 61713888	

Italia	SMA Italia S.r.l. Milano	+39 02 8934-7299	
Κύπρος/ Kıbrıs	Βλέπε Ελλάδα/ Bkz. Ελλάδα (Yunanistan)		
Luxemburg/ Luxembourg	Siehe Belgien Voir Belgique		
Magyarország	lásd Česko (Csehország)		
Nederland	zie Belgien (België)		
Österreich	Siehe Deutschland		
Perú	Ver España		
Polska	Patrz Česko (Czechy)		
Portugal	SMA Solar Technology Portugal, Unipessoal Lda Lisboa	Isento de taxas em Portugal: Internacional:	800 20 89 87 +351 2 12 37 78 60
România	Vezi Česko (Cehia)		
Schweiz	Siehe Deutschland		
Slovensko	pozri Česko (Česká republika)		
South Africa	SMA Solar Technology South Africa Pty Ltd. Centurion (Pretoria)	08600 SUNNY (08600 78669) International:	+27 (12) 643 1785
United Kingdom	SMA Solar UK Ltd. Milton Keynes	+44 1908 304899	
Ελλάδα	SMA Hellas AE Αθήνα	801 222 9 222 International:	+30 212 222 9 222
България	Вижте Ελλάδα (Γърция)		
ไทย	SMA Solar (Thailand) Co., Ltd. บริษัท สแม โซลาร์ เทคโนโลยี จำกัด	+66 2 670 6999	
대한민국	SMA Technology Korea Co., Ltd. 서울	+82 2 508-8599	
中国	SMA Beijing Commercial Company Ltd. 北京	+86 10 5670 1350	
日本	SMA Japan K.K. 東京	+81 3 3451 9530	
+971 2 698-5080	SMA Middle East LLC أبو ظبي		الإمارات العربية المتحدة

Other countries International SMA Service Line  
Niestetal

Toll free worldwide: 00800 SMA SERVICE  
(+800 762 7378423)



**SMA Solar Technology**

**[www.SMA-Solar.com](http://www.SMA-Solar.com)**

